

CHAPTER 8. ENGINES, FUEL, EXHAUST, AND PROPELLERS

SECTION 1. ENGINES

8-1. GENERAL. Consult the manufacturer's manuals, service bulletins, and instruction books regarding the repair and overhaul, inspection, installation, and maintenance of aircraft engines, for that particular make, model, and type of engine. This section lists acceptable inspection and repair procedures that may be used in the absence of an engine manufacturer's maintenance information.

8-2. SPECIAL INSPECTION. A visual inspection is needed to determine the condition of the engine and its components. An annual or 100-hour inspection should include the engine and nacelle group as follows.

a. Cold Cylinder Check. If an engine is running rough the cause may be a bad ignition lead, a spark plug not firing, a partially clogged fuel injector, or a bad magneto. The dead cylinder will be colder than the surrounding cylinders and can be quickly determined by using the recommended cold cylinder checks. This should be done using a thermocouple probe which is very sensitive to small differences in temperature, which is the case with a partially-clogged injector. For a carbureted engine, the following check may be helpful:

(1) Using experienced personnel, run the engine on the bad magneto for approximately 30 seconds at 1200 rpm. Without switching the magneto switch back to both shut off the engine. Have another mechanic use a grease pencil (non-carbon), and quickly mark each exhaust stack approximately 1 inch from the flange that holds the exhaust stack to the cylinder. Next, check the exhaust stacks and look for the exhaust stack whose grease

pencil mark has not turned to a grayish-white or ash color. This is the cold cylinder.

(2) The probable cause of the cold cylinder is either a defective spark plug or ignition lead. Switch spark plugs to another cylinder and run the test again. If the problem stays with the original cylinder, the problem is either the ignition lead or the magneto.

b. Piston Engine Sudden Stoppage Inspection. Sudden stoppage is a very rapid and complete stoppage of the engine. It can be caused by engine seizure or by one or more of the propeller blades striking an object in such a way that rpm goes to zero in less than one complete revolution of the propeller. Sudden stoppage can cause internal damage to constant-speed propellers; reduction drive; gear train damage in the accessory section; crankshaft misalignment; or damage to accessories such as magnetos, generators, vacuum pumps, and tach generators.

(1) Every engine that suffers a sudden stoppage must be inspected in accordance with the manufacturer's maintenance instructions before being returned to service.

(2) If the engine manufacturer does not provide the required information, then the engine case must be opened and every major component part must be inspected using visual and/or nondestructive inspection (NDI) procedures as applicable.

(3) The sudden-stoppage inspections include: checking for cowling, spinner, and airframe cracks and hidden damage; and alignment of the engine mount to the airframe,

the mounting hardware, isolation mounts, and bushings. The aircraft's firewall must also be checked for distortion, cracks, and elongated bolt holes. The damaged propeller must be sent to an FAA-certificated repair station for complete NDI and repair.

(4) Engine accessories such as: magnetos, starters, fuel pumps, turbochargers, alternators, or generators must be inspected in accordance with the manufacturer's maintenance manual on sudden stoppage or overhaul procedures to determine the product's airworthiness.

c. Reciprocating Engine (Direct Drive).
Preliminary inspection before tear down.

(1) Remove the engine cowling and examine the engine for visible external damage and audible internal damage.

(2) Rotate the propeller shaft to determine any evidence of abnormal grinding or rubbing sounds.

(3) With the propeller removed, inspect the crankshaft flange or splines for signs of twisting, cracks, or other deformation. Remove the thrust-bearing nut and seal and thoroughly inspect the threaded area of the shaft for evidence of cracks.

(4) Rotate the shaft slowly in 90-degree increments while using a dial indicator or an equivalent instrument to check the concentricity of the shaft.

(5) Remove the oil sump drain plug and check for metal chips and foreign material.

(6) Remove the oil screens and inspect for metal particles and contamination.

(7) Visually inspect engine case exterior for signs of oil leaks and cracks. Give

particular attention to the propeller thrust-bearing area of the nose case section.

(8) Inspect cylinders and cylinder hold-down area for cracks and oil leaks. Thoroughly investigate any indication of cracks, oil leaks, or other damage.

d. Internal Inspection Requirements.

(1) On engines equipped with crankshaft vibration dampers, remove and inspect the cylinders, and inspect the crankshaft dampers in accordance with the engine manufacturer's inspection and overhaul manual. When engine design permits, remove the damper pins, and examine the pins and damper liners for signs of nicks or brinelling.

(2) After removing the engine-driven accessories, remove the accessory drive case and examine the accessory and supercharger drive gear train, couplings, and drive case for evidence of damage.

(a) Check for cracks in the case in the area of accessory mount pads and gear shaft bosses.

(b) Check the gear train for signs of cracked, broken, or brinelled teeth.

(c) Check the accessory drive shaft couplings for twisted splines, misalignment, and run-out.

(d) Check connecting rods for cracks and straightness.

e. Reciprocating Engine (Gear-Drive).
Inspect the engine, propeller, (refer to section 4 on propeller inspection), and components as described in the preceding paragraphs.

(1) Remove the propeller reduction gear housing and inspect for:

(a) Loose, sheared, or spalled cap screws or bolts.

(b) Cracks in the case.

(2) Disassemble the gear train and inspect the propeller shaft, reduction gears and accessory drive gears for nicks, cracks, or spalling.

f. Engine-Mount Inspection.

(1) Examine the engine flex mounts when applicable, for looseness of engine to mount, distortion, or signs of wear.

(2) Inspect the engine-mount structure for bent, cracked, or buckled tubes.

(3) Check the adjacent airframe structure firewall for cracks, distortion, or wrinkles.

(4) Remove engine-mount bolts and mount hold-down bolts and replace.

g. Exhaust-driven Supercharger (Turbo) Inspection. Sudden stoppage of the powerplant can cause the heat in turbine parts to heat-soak the turbine seals and bearings. This excessive heat causes carbon to develop in the seal area and varnish to form on the turbine bearings and journals.

(1) Inspect all air ducts and connections for air leaks, warpage, or cracks.

(2) Remove compressor housing and check the turbine wheel for rubbing or binding, and coke or varnish buildup.

NOTE: Turbine turbo supercharger disk seal rubbing is not unusual and may be a normal condition. Consult the engine manufacturer's inspection procedures and table of limits.

h. Accessory and Drive Inspection. Check the drive shaft of each accessory, i.e., magnetos, generators, external superchargers, and pumps for evidence of damage.

8-3. CRANKSHAFT INSPECTION AND REPAIR REQUIREMENTS. Carefully inspect for misalignment and replace if bent beyond the manufacturer's permissible service limit. Worn journals may be repaired by re-grinding in accordance with manufacturers' instructions. It is recommended that grinding operations be performed by appropriately-rated repair stations or the original engine manufacturer. Common errors that occur in crankshaft grinding are the removal of nitrided journal surface, improper journal radii, unsatisfactory surfaces, and grinding tool marks on the journals. If the fillets are altered, do not reduce their radii. Polish the reworked surfaces to assure removal of all tool marks. Most opposed engines have nitrided crankshafts, and engine manufacturers specify that these crankshafts must be re-nitrided after grinding.

NOTE: Rapid deceleration or momentary slowing of a propeller may occur due to contact with tall grass, water, or snow. If this occurs, the engine and propeller should be inspected in accordance with the manufacturer's instruction or service bulletins.

8-4. REPLACEMENT PARTS IN CERTIFICATED ENGINES. Engine replacement parts must be approved under Title 14 of the Code of Federal Regulations (14 CFR), part 21. Serviceable parts obtained from the engine manufacturer, authorized service facility, and those which are approved Federal Aviation Administration (FAA)/Parts Manufacture Approval (PMA), or Technical Standard Order (TSO), and meet the requirements of part 21 are acceptable for use as replacement parts. Used engine parts can be installed

if that part either conforms to new part tolerances or meets the manufacturer's service limits. Ensure that used parts are airworthy and properly identified as a PMA or TSO part.

8-5. OIL SYSTEM LINES INSPECTION.

The inspection of the plumbing for an oil system is similar to the inspection of any other plumbing system. The tubing, hose, tube fittings, hose fittings, hose clamps, and all other components of the system are inspected for cracks, holes, dents, bulges, and other signs of damage that might restrict the oil flow or cause a leak. All lines are inspected to ensure that they are properly supported and are not rubbing against a structure. Fittings should be checked for signs of improper installation, over-torquing, excessive tension, or other conditions which may lead to failure.

8-6. OIL FILTER INSPECTION. The oil filter provides an excellent method for discovering internal engine damage. During the inspection of the engine oil filter, the residue on the screens, disks, or disposable filter cartridge and the residue in the filter housing are carefully examined for metal particles. A new engine or a newly-overhauled engine will often have a small amount of fine metal particles in the screen or filter, but this is not considered abnormal. After the engine has been operated for a time and the oil has been changed one or more times, there should not be an appreciable amount of metal particles in the oil screen. If an unusual residue of metal particles is found in the oil screen, the engine must be taken out of service and disassembled to determine the source of the particles. As an additional precaution, an oil analysis/trend analysis may prevent an engine failure in flight.

At oil changes, oil samples are often taken and sent to laboratories to be analyzed for wear by determining the amount of metal in the sample. Over time, a trend is developed and the engine can be removed from service before failure.

8-7. CYLINDER HOLD-DOWN NUTS AND CAP SCREWS. Great care is required in tightening cylinder hold-down nuts and cap screws. They must be tightened to recommended torque limits to prevent improper stressing and to ensure even loading on the cylinder flange. The installation of baffles, brackets, clips, and other extraneous parts under nuts and cap screws is not a good practice and is discouraged. If these baffles, brackets, etc., are not properly fabricated or made of suitable material, they may cause loosening of the nuts or cap screws even though the nuts or cap screws were properly tightened and locked at installation. Improper pre-stressing or loosening of any one of these nuts or cap screws will introduce the danger of progressive stud failure with the possible loss of the engine cylinder in flight.

8-8. REUSE OF SAFETYING DEVICES.

Do not use cotter pins and safety wire a second time. Flat, steel-type wrist pin retainers and lock washers, likewise, must be replaced at overhaul unless the manufacturer's recommendations permit their reuse.

8-9. SELF-LOCKING NUTS FOR AIRCRAFT ENGINES AND ACCESSORIES.

Self-locking nuts may be used on aircraft engines provided the following criteria are met:

- a. **When their use is specified** by the engine manufacturer in the assembly drawing, parts list, and bills of material.
- b. **When the nuts will not fall inside** the engine should they loosen and come off.
- c. **When there is at least one full thread** protruding beyond the nut.
- d. **Where the temperature will not exceed the maximum limits** established for the self-locking material used in the nut. On many

engines the cylinder baffles, rocker box covers, drive covers and pads, and accessory and supercharger housings are fastened with fiber insert lock nuts which are limited to a maximum temperature of 250 °F. Above this temperature, the fiber insert will usually char and, consequently, lose its locking characteristic. For locations such as the exhaust pipe attachment to the cylinder, a locknut which has good locking features at elevated temperatures will give invaluable service. In a few instances, fiber insert lock nuts have been approved for use on cylinder hold-down studs. This practice is not generally recommended, since especially tight stud fits to the crankcase must be provided, and extremely good cooling must prevail so that low temperatures exist where the nut is installed.

e. Information concerning approved self-locking nuts and their use on specific engines are usually found in engine manufacturer's manuals or bulletins. If the desired information is not available, it is suggested that the engine manufacturer be contacted.

f. Refer to Chapter 7, Aircraft Hardware, Control Cables, and Turnbuckles, for additional information on self-locking nuts.

8-10. METALLIZING. Metallizing internal parts of aircraft engines is not acceptable unless it is proven to the FAA that the metallized part will not adversely affect the airworthiness of the engine. Metallizing the finned surfaces of steel cylinder barrels with aluminum is acceptable, since many engines are originally manufactured in this manner.

8-11. PLATING. Before restoring the plating on any engine part in accordance with the manufacturer's instructions, the part should be visually inspected and have an NDI performed before any cylinder reconditioning. In general, chromium plating would not be applied to highly-stressed engine parts. Certain applications of this nature have been found to be satis-

factory; however, engineering evaluation of the details for the processes used should be obtained.

a. Dense chromium plating of the crankpin and main journals of some small engine crankshafts has been found satisfactory, except where the crankshaft is already marginal in strength. Plating to restore worn, low-stress engine parts, such as accessory drive shafts and splines, propeller shaft ends, and seating surfaces of roller and ball-type bearing races is acceptable but requires compliance with FAA-approved data.

b. Porous chromium-plated walls of cylinder barrels have been found to be satisfactory for practically all types of engines. Dense or smooth chromium plating, without roughened surfaces on the other hand, has not been found to be satisfactory.

(1) Cylinder barrel pre-grinding and chromium plating techniques used by the military are considered acceptable for all engines, and military-approved facilities engaged in doing this work in accordance with military specifications are eligible for approval by the FAA.

(2) Chromium-plated cylinder barrels have been required for some time to be identified in such a manner that the markings are visible with the cylinder installed. Military-processed cylinders are banded with orange enamel above the mounting flange. It has been the practice to etch on either the flange edge or on the barrel skirt the processor's initials and the cylinder oversize. Most plating facilities use the orange band as well as the permanent identification marks.

(3) A list of engine and maximum permissible cylinder barrel oversize are referenced in table 8-1.

TABLE 8-1. Current engine and maximum permissible cylinder barrel oversize.

Engine manufacturer	Engine series	Max. oversize (in.)
Air Cooled Motors (Franklin)	No oversize for sleeved cylinders. Solid cylinders.....	0.017
Continental Motors	R-670, W-670, R9A....	0.010 to 0.020
	GTSIO-520, 550.....	0.005 to 0.015
	All others.....	0.015
Jacobs	All.....	0.015
Kinner	All.....	0.015
Pigman, LeBlond, Rearwin, Ken Royce	All.....	0.025
Lycoming	All.....	0.010 to 0.020
Menasco	All.....	0.010
Pratt & Whitney	R-2800B, C, CA, CB.. *R-959 and R-1830....	0.025 to 0.030
	All others.....	0.020
Ranger	6-410 early cyls. 6-390	0.010
	6-410 late cyls. 6-440 (L-440) series..	0.120
Warner	All.....	0.015
Wright	All.....	0.020
*(The above oversize limits correspond to the manufacturer's requirements, except for P&W R-985 and R-1830 series engines.)		
NOTE: (Check for latest manufacturer specifications.)		

(4) Cylinder barrels which have been plated by an agency whose process is approved by the FAA and which have not been worked beyond maximum permissible limits, will be considered acceptable for installation on certificated engines. It will be the responsibility of the owner or the repairing agency to provide this proof. In some cases, it may be necessary to remove cylinders to determine the amount of oversize since this information may be etched on the mating surface of the cylinder base flange.

8-12. CORROSION. Accomplish corrosion preventive measures for temporary and long-term storage in accordance with the instructions issued by the pertinent engine manufacturer. Avoid the use of solutions which contain strong caustic compounds and all solutions, polishes, cleaners, abrasives, etc., which

might possibly promote corrosive action. (Refer to Chapter 6, Corrosion, Inspection, and Protection.)

8-13. ENGINE RUN-IN. After an aircraft engine has been overhauled, it is recommended that the pertinent aircraft engine manufacturer's run-in instructions be followed. Observe the manufacturer's recommendations concerning engine temperatures and other criteria. Repair processes employed during overhaul often necessitate amending the manufacturer's run-in procedures. Follow the approved amended run-in procedures in such instances.

NOTE: Do not run up engines on the ground for long periods of time with the cowl off. The engine will over-heat because cylinder cooling has been disrupted.

8-14. COMPRESSION TESTING OF AIRCRAFT ENGINE CYLINDERS. A test to determine the internal condition of the combustion chamber cylinder assembly by ascertaining if any appreciable internal leakage is occurring is compression testing of aircraft engine cylinders. If a cylinder has less than a 60/80 reading on the differential test gauges on a hot engine, and procedures in paragraphs 8-15b(5)(i) and (j) fail to raise the compression reading, the cylinder must be removed and inspected. To determine the cylinder's problem area, have someone hold the propeller at the weak cylinder's top dead center and with compressed air still being applied, listen. If air is heard coming out of the exhaust pipe, the cylinder's exhaust-valve is not seating properly. If air is heard leaking out of the air cleaner/carburetor heat box, the intake valve is leaking. With the oil dipstick removed, and air is rushing out, the piston rings are defective. Remove and repair/overhaul the defective cylinder.

a. Differential Compression Test. The most common type of compression tester currently in use is the differential pressure-type tester. It provides a cross-reference to validate the readings obtained and tends to assure that the cylinder is defective before it is removed. Before beginning a compression test, consider the following points:

(1) When the spark plugs are removed from the engine, identify them to coincide with the cylinder and location from which they were removed. Close examination of the plugs will reveal the actual operating conditions and aid in diagnosing problems within each individual cylinder.

(2) The operating and maintenance records of the engine should be reviewed. Records of previous compression tests are of assistance in determining progressive wear conditions and help to establish the necessary maintenance corrective actions.

b. Differential Pressure Compression Test. The differential pressure tester is designed to check the compression of aircraft engines by measuring the leakage through the cylinders caused by worn or damaged components. The operation of the compression tester is based on the principle that, for any given air-flow through a fixed orifice, a constant pressure drop across that orifice will result. The restrictor orifice dimensions in the differential pressure tester should be sized for the particular engine as follows:

(1) For an engine cylinder having less than a 5.00-inch bore; 0.040-inch orifice diameter; .250 inch long; and a 60-degree approach angle.

(2) For an engine cylinder with 5.00 inch bore and over: 0.060 inch orifice diameter, .250 inch long, 60 degree approach angle.

(3) A typical schematic diagram of the differential pressure tester is shown in figure 8-1.

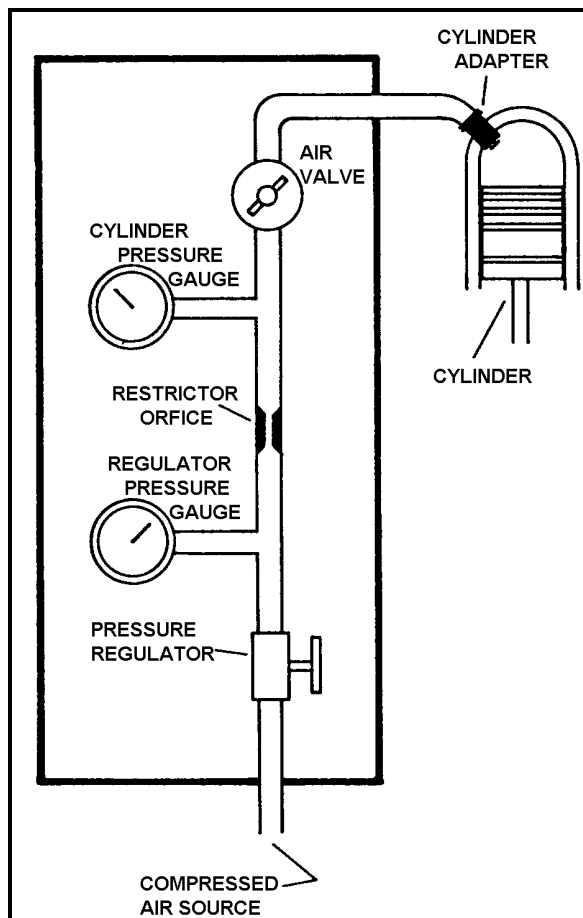

FIGURE 8-1. Schematic of differential pressure compression tester.

(4) As the regulated air pressure is applied to one side of the restrictor orifice with the air valve closed, there will be no leakage on the other side of the orifice and both pressure gauges will read the same. However, when the air valve is opened and leakage through the cylinder increases, the cylinder pressure gauge will record a proportionally lower reading.

(5) While performing the check the following procedures are listed to outline the principles involved, and are intended to supplement the manufacturer's instructions for the particular tester being used.

(a) Perform the compression test as soon as possible after the engine is shut down to ensure that the piston rings, cylinder walls, and other engine parts are well-lubricated.

(b) Remove the most accessible spark plug from each cylinder.

(c) With the air valve closed, apply an external source of clean air (approximately 100 to 120 psi) to the tester.

(d) Install an adapter in the spark plug bushing and connect the compression tester to the cylinder.

(e) Adjust the pressure regulator to obtain a reading of 20 psi on the regulator pressure gauge. At this time, the cylinder pressure gauge should also register 20 psi.

(f) Turn the crankshaft, by hand, in the direction of rotation until the piston (in the cylinder being checked) is coming up on its compression stroke. Slowly open the air valve and pressurize the cylinder to 80 psi.

CAUTION: Care must be exercised in opening the air valve since sufficient air pressure will have built up in the cylinder to cause it to rapidly rotate the propeller if the piston is not at top dead center (TDC).

(g) Continue rotating the engine against this pressure until the piston reaches TDC. Reaching TDC is indicated by a flat spot or sudden decrease in force required to turn the crankshaft. If the crankshaft is rotated too far, back up at least one-half revolution and start over again to eliminate the effect of backlash in the valve operating mechanism and to keep piston rings seated on the lower ring lands.

(h) Open the air valve completely. Check the regulated pressure and readjust, if necessary, to read 80 psi.

(i) Observe the pressure indication of the cylinder pressure gauge. The difference between this pressure and the pressure shown by the regulator pressure gauge is the amount of leakage through the cylinder. A loss in excess of 25 percent of the input air pressure is cause to suspect the cylinder of being defective; however, recheck the readings after operating the engine for at least 3 minutes to allow for sealing of the rings with oil.

(j) If leakage is still occurring after a recheck, it may be possible to correct a low reading. This is accomplished by placing a fiber drift on the rocker arm directly over the valve stem and tapping the drift several times with a hammer to dislodge any foreign material between the valve face and seat.

NOTE: When correcting a low reading in this manner, rotate the propeller so the piston will not be at TDC. This is necessary to prevent the valve from striking the top of the piston in some engines. Rotate the engine before rechecking compression to reseal the valves in the normal manner.

8-15. SPARK PLUGS. The spark plug provides the high-voltage electrical spark to ignite the fuel/air mixture in the cylinder. The types of spark plugs used in different engines will vary with regard to heat range, reach, thread size, and other characteristics required by the particular installation.

a. Heat Range. The heat range of a spark plug is the principal factor governing aircraft performance under various service conditions. The term "heat range" refers to the

classification of spark plugs according to their ability to transfer heat from the firing end of the spark plug to the cylinder head.

(1) Spark plugs have been classified as “hot,” “normal,” and “cold.” However, these terms may be misleading because the heat range varies through many degrees of temperature from extremely hot to extremely cold. Thus the words “hot,” “cold,” and “normal” do not necessarily tell the whole story.

(2) Since the insulator is designed to be the hottest part of the spark plug, its temperature can be related to the pre-ignition and fouling regions as shown in figure 8-2. Pre-ignition is likely to occur if surface areas in the combustion chamber exceed critical limits or if the spark plug core nose temperature exceeds 1,630 °F (888 °C). However, fouling or short-circuiting of the plug due to carbon deposits is likely to occur if the insulator tip temperature drops below approximately 800 °F (427 °C). Since spark plugs must operate between fairly well-defined temperature limits, they must be supplied in various heat ranges to meet the requirements of different engines under a variety of operating conditions.

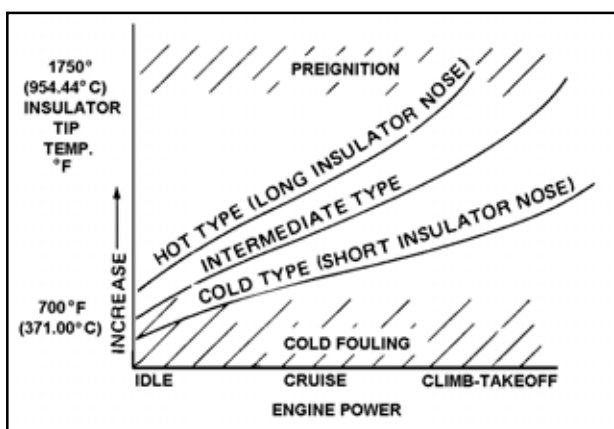

FIGURE 8-2. Chart of spark plug temperature ranges.

(3) From the engineering standpoint, each individual plug must be designed to offer the widest possible operating range. This means that a given type of spark plug should

operate as hot as possible at low speeds and light loads and as cool as possible under cruising and takeoff power. Plug performance, therefore, depends on the operating temperature of the insulator nose, with the most desirable temperature range falling between 1,000 °F and 1,250 °F (538 °C and 677 °C).

(4) Fundamentally, an engine which runs hot requires a relatively cold spark plug, whereas an engine which runs cool requires a relatively hot spark plug. If a hot spark plug is installed in an engine which runs hot, the spark plug tip will be overheated and cause pre-ignition. If a cold spark plug is installed in an engine which runs cool, the tip of the spark plug will collect unburned carbon, causing fouling of the plug. The principal factors governing the heat range of aircraft spark plugs are:

- (a) the distance between the copper sleeve around the insulator and the insulator tip;
- (b) the thermal conductivity of the insulating material;
- (c) the thermal conductivity of the electrode;
- (d) the rate of heat transfer between the electrode and the insulator;
- (e) the shape of the insulator tip;
- (f) the distance between the insulator tip and the shell; and
- (g) the type of outside gasket used.

(5) “Hot” plugs have a long insulator nose; thereby, creating a long heat transfer path, whereas “cold” plugs have a relatively short insulator to provide a rapid transfer of heat to the cylinder head. (See figure 8-3.)

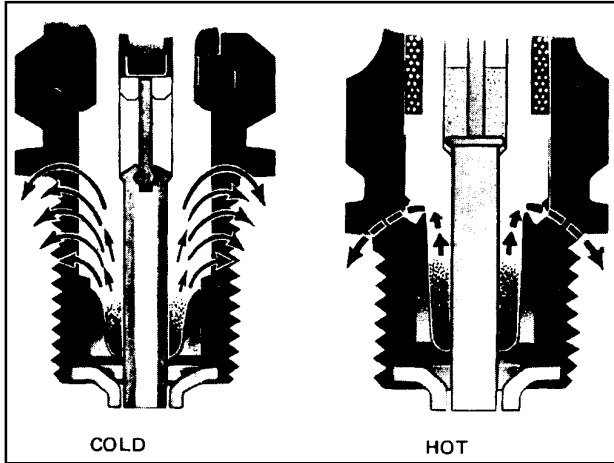

FIGURE 8-3. Hot and cold spark plugs.

b. Reach. The spark plug reach (see figure 8-4) is the threaded portion which is inserted into the spark plug bushing of the cylinder. A plug with the proper reach will ensure that the electrode end inside the cylinder is in the best position to achieve ignition. Spark plug seizure or improper combustion within the cylinder will probably occur if a plug with the wrong reach is used. Shell threads of spark plugs are classified as 14- or 18-mm spark plug diameter, long reach or short reach, thus:

Diameter	Long reach	Short reach
14 mm	1/2 in (12.7 mm)	3/8 in (9.53 mm)
18 mm	13/16 in. (20.64 mm)	1/2 in (12.7 mm)

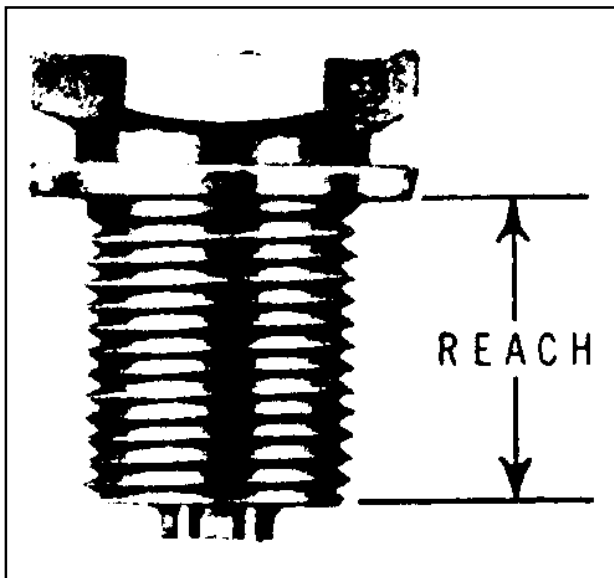

FIGURE 8-4. Spark plug reach.

c. Installation Procedures. When installing spark plugs, observe the following procedure.

- (1) Visually inspect the plug for cleanliness and condition of the threads, ceramic, and electrodes.

NOTE: Never install a spark plug which has been dropped and always use new gaskets every time you install a spark plug.

- (2) Check the plug for the proper gap setting, using a round wire feeler gauge as shown in figure 8-5. In the case of used plugs, procedures for cleaning and regapping are usually contained in the various manufacturers' manuals.

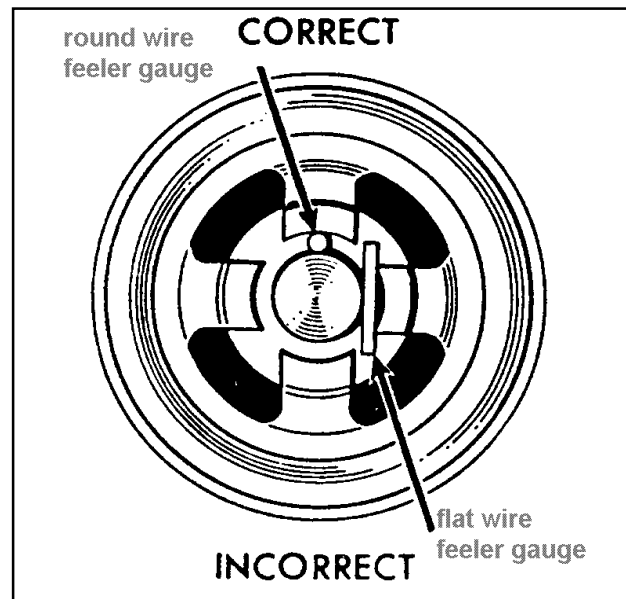

FIGURE 8-5. Method of checking spark plug gap.

- (3) Check the plug and cylinder bushing to ascertain that only one gasket is used per spark plug. When a thermocouple-type gasket is used, no other gasket is required.

- (4) Apply anti-seize compound sparingly to the shell threads, but do not allow the compound to contact the electrodes since the material is conductive and will short out the

plug. If desired, the use of anti-seize compound may be eliminated on engines equipped with stainless steel spark plug bushings or inserts.

(5) Screw the plug into the cylinder head as far as possible by hand. If the plug will not turn easily to within two or three threads of the gasket, it may be necessary to clean the threads.

NOTE: Cleaning inserts with a tap is not recommended as permanent damage to the insert may result.

(6) Seat the proper socket securely on the spark plug and tighten to the torque limit specified by the engine manufacturer before proceeding to the next plug.

CAUTION: A loose spark plug will not transfer heat properly, and during engine operation, may overheat to the point the nose ceramic will become a "hot spot" and cause pre-ignition. However, avoid over-tightening as damage to the plug and bushing may result.

(7) Connect the ignition lead after wiping clean with a dry, lint-free cloth. Insert the terminal assembly into the spark plug in a straight line. (Care should be taken as improper techniques can damage the terminal sleeves.) Screw the connector nut into place until finger tight, then tighten an additional one quarter turn while holding the elbow in the proper position.

(8) Perform an engine run-up after installing a new set of spark plugs. When the engine has reached normal operating temperatures, check the magnetos and spark plugs in accordance with the manufacturer's instructions.

8-16. OPERATIONAL PROBLEMS.

Whenever problems develop during engine operation, which appear to be caused by the ignition system, it is recommended that the spark plugs and ignition harnesses be checked first before working on the magnetos. The following are the more common spark plug malfunctions and are relatively easy to identify.

a. Fouling.

(1) Carbon fouling (see figure 8-6) is identified by the dull black, sooty deposits on the electrode end of the plug. Although the primary causes are excessive ground idling and rich idle mixtures, a cold heat range may also be a contributing factor.

(2) Lead fouling is characterized by hard, dark, cinder-like globules which gradually fill up the electrode cavity and short out the plug. (See figure 8-6a.) The primary cause for this condition is poor fuel vaporization combined with a high tetraethyl-lead content fuel. A cold heat range may also contribute to this condition.

(3) Oil fouling is identified by a wet, black carbon deposit over the entire firing end of the plug as shown in figure 8-6b. This condition is fairly common on the lower plugs in horizontally-opposed engines, and both plugs in the lower cylinders of radial engines. Oil fouling is normally caused by oil drainage past the piston rings after shutdown. However, when both spark plugs removed from the same cylinder are badly fouled with oil and carbon, some form of engine damage should be suspected, and the cylinder more closely inspected. Mild forms of oil fouling can usually be cleared up by slowly increasing power, while running the engine until the deposits are burned off and the misfiring stops.



FIGURE 8-6. Typical carbon-fouled spark plug.

b. Fused Electrodes. There are many different types of malfunctions which result in fused spark plug electrodes; however, most are associated with pre-ignition either as the cause or the effect. For this reason, any time a spark plug is found with the following defects, further investigation of the cylinder and piston should be conducted.

(1) Occasionally, the ceramic nose core will crack, break away, and remain trapped behind the ground electrode. This piece of insulation material will then buildup heat to the point it will ignite the fuel/air mixture prematurely. The high temperatures and pressures encountered during this condition can cause damage to the cylinder and piston and ultimately lead to fusing and shorting out of the plug. (See figure 8-6c.)

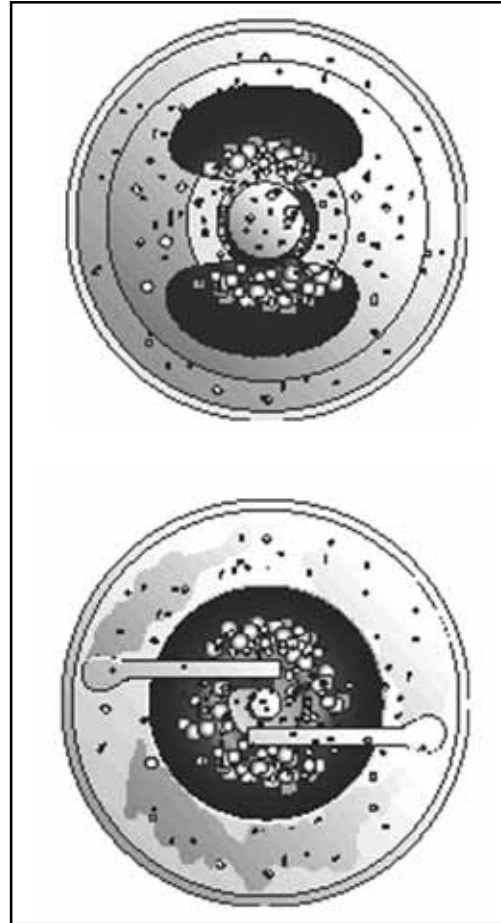

FIGURE 8-6a. Typical lead-fouled spark plug.

(2) Corrosive gases formed by combustion and the high voltage spark have eroded the electrodes. Spark plugs in this condition require more voltage to fire—often more than the ignition system can produce. (See figure 8-6d.)

c. Bridged Electrodes. Occasionally, free combustion chamber particles will settle on the electrodes of a spark plug and gradually bridge the electrode gap, resulting in a shorted plug. Small particles may be dislodged by slowly cycling the engine as described for the oil-fouled condition; however, the only remedy for more advanced cases is removal and replacement of the spark plug. This condition is shown in figure 8-6e.

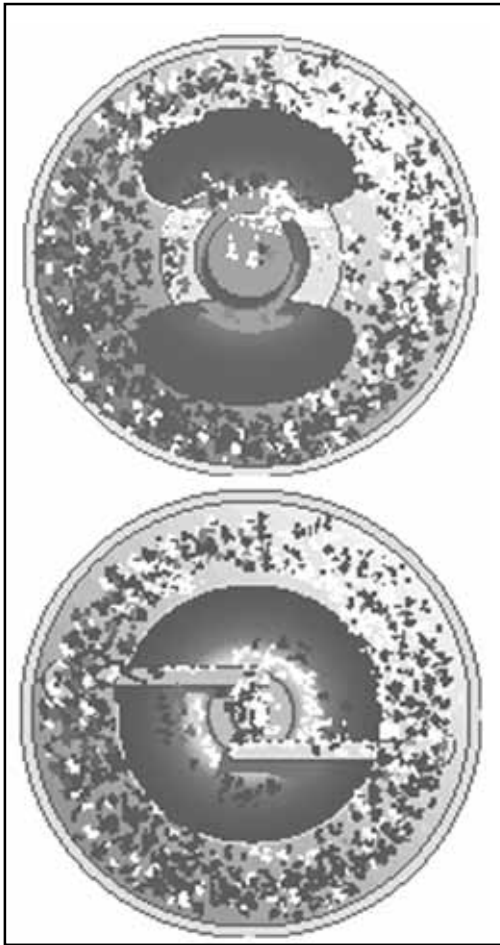

FIGURE 8-6b. Typical oil-fouled spark plug.

d. Metal Deposits. Whenever metal spray is found on the electrodes of a spark plug, it is an indication that a failure of some part of the engine is in progress. The location of the cylinder in which the spray is found is important in diagnosing the problem, as various types of failures will cause the metal spray to appear differently. For example, if the metal spray is located evenly in every cylinder, the problem will be in the induction system, such as an impeller failure. If the metal spray is found only on the spark plugs in one cylinder, the problem is isolated to that cylinder and will generally be a piston failure.

In view of the secondary damage which occurs whenever an engine part fails, any preliminary indication such as metal spray should be thoroughly investigated to establish and correct the cause.

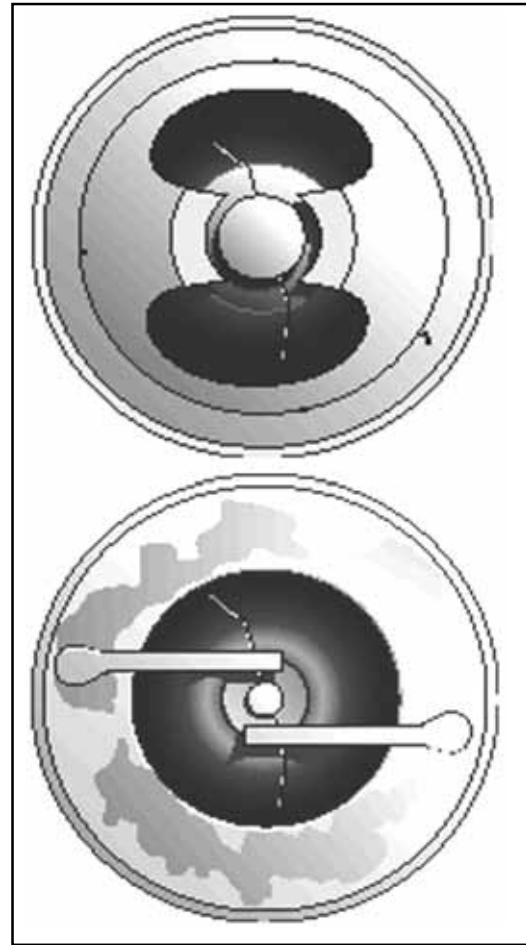

FIGURE 8-6c. Typical spark plug with cracked core nose.

e. Flashover. It is important that spark plug terminal contact springs and moisture seals be checked regularly for condition and cleanliness to prevent “flashover” in the connector well. Foreign matter or moisture in the terminal connector well can reduce the insulation value of the connector to the point the ignition system voltages at higher power settings may flash over the connector well surface to ground and cause the plug to misfire. If moisture is the cause, hard starting can also result. The cutaway spark plug shown in figure 8-7 illustrates this malfunction. Any spark plug found with a dirty connector well may have this condition, and should be reconditioned before reuse.

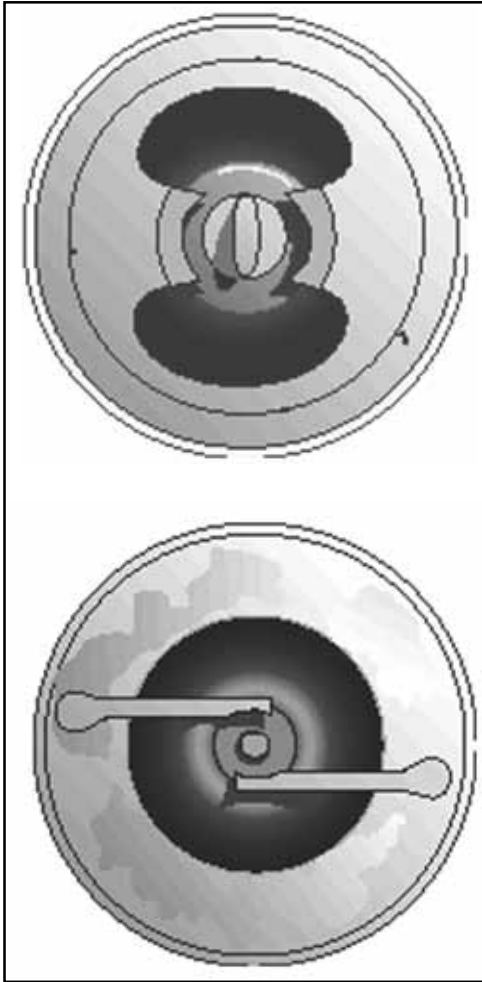

FIGURE 8-6d. Typical worn out spark plug.

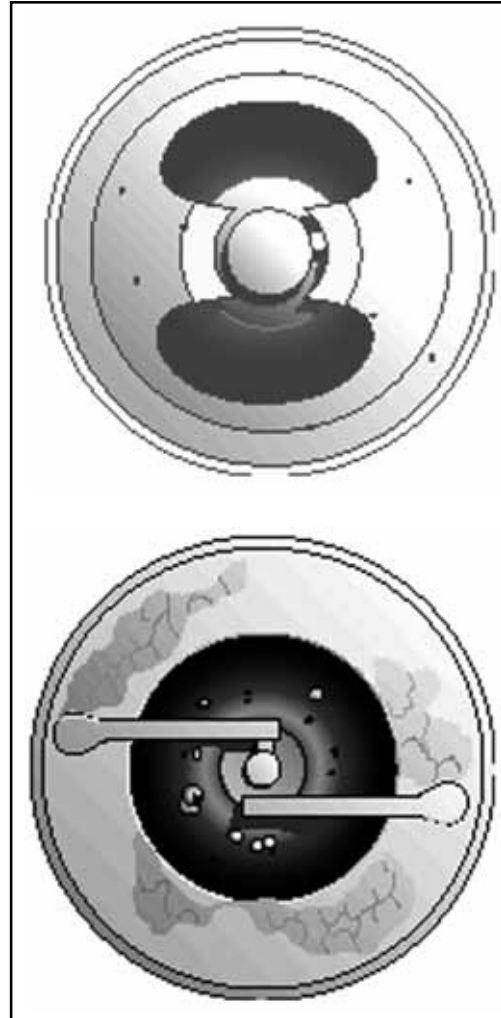

FIGURE 8-6e. Typical spark plug with bridged electrodes.

8-17. SPARK PLUG PRE-RECONDITIONING INSPECTION.

All spark plugs should be inspected visually before reconditioning to eliminate any plug with obvious defects. A partial checklist of common defects includes:

- a. **Chipped or cracked ceramic** either at the nose core or in the connector well.
- b. **Damaged or badly worn electrodes.**
- c. **Badly nicked, damaged, or corroded threads** on shell or shielding barrel.
- d. **Dented, bent, or cracked shielding barrel.**
- e. **Connector seat at the top of the shielding barrel** badly nicked or corroded.

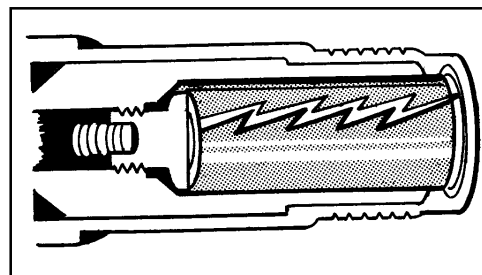

FIGURE 8-7. Spark plug well flashover.

8-18. IGNITION HARNESSES INSPECTION.

Aircraft-quality ignition harness is usually made of either medium or high-temperature wire. The type used will depend upon the manufacturing specification for the particular engine. In addition to the applicable manufacturer's maintenance and repair procedures, the following is a quick-reference

checklist for isolating some of the malfunctions inherent to ignition harnesses.

a. Carefully inspect the lead conduit or shielding. A few broken strands will not affect serviceability, but if the insulation in general looks worn, replace the lead.

b. When replacing a lead, if the dressing procedure is not accomplished properly, strands of shielding may be forced through the conductor insulation. If this occurs, a short will exist in the conductor; therefore, it is essential this task be performed properly.

c. The high-temperature coating used on some lightweight harnesses is provided for vibration abrasion resistance and moisture protection. Slight flaking or peeling of this coating is not serious, and a harness assembly need not be removed from service because of this condition.

d. Check the spark plug contact springs for breaks, corrosion, or deformation. If possible, check the lead continuity from the distributor block to the contact spring.

e. Check the insulators at the spark plug end of the lead for cracks, breaks, or evidence of old age. Make sure they are clean.

f. Check to see that the leads are positioned as far away from the exhaust manifold as possible and are supported to prevent any whipping action.

g. When lightweight harnesses are used and the conduit enters the spark plug at a severe angle, use clamps as shown in figure 8-8 to prevent overstressing the lead.

8-19. MAGNETO INSPECTION. Whenever ignition problems develop and it is determined that the magneto is the cause of the difficulty, the following are a few simple inspection procedures which may locate the mal-

function quickly. However, conduct any internal inspection or repair of a magneto in accordance with the manufacturer's maintenance and overhaul manuals.

a. Inspect the distributor block contact springs. If broken or corroded, replace.

b. Inspect the felt oil washer, if applicable. It should be saturated with oil. If it is dry, check for a worn bushing.

c. Inspect the distributor block for cracks or a burned area. The wax coating on the block should not be removed. Do not use any solvents for cleaning.

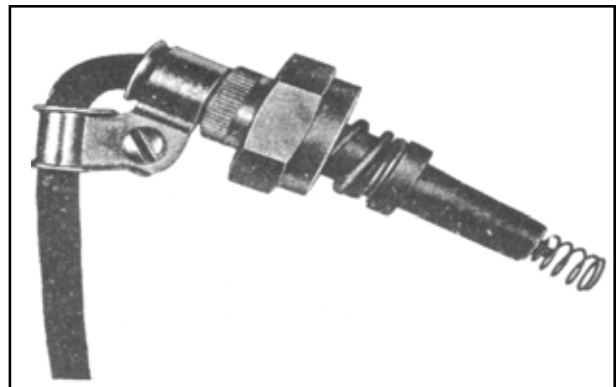

FIGURE 8-8. Typical method of clamping leads.

d. Look for excess oil in the breaker compartment. If oil is present, it may indicate a bad oil seal or bushing at the drive end. This condition could require complete overhaul, as too much oil may foul and cause excessive burning of the contact points.

e. Look for frayed insulation on the leads in the breaker compartment of the magneto. See that all terminals are secure. Be sure that wires are properly positioned.

f. Inspect the capacitor visually for general condition, and check the mounting bracket for cracks or looseness. If possible, check the capacitor for leakage, capacity, and series resistance.

g. Examine the points for excessive wear or burning. Discard points which have deep pits or excessively burned areas. Desired contact surfaces have a dull gray, sandblasted (almost rough) or frosted appearance over the area where electrical contact is made. Figure 8-9 shows how the normal contact point will look when surfaces are separated for inspection. Minor irregularities or roughness of point surfaces are not harmful (see figure 8-10), neither are small pits or mounds, if not too pronounced. If there is a possibility of the pit becoming deep enough to penetrate the pad (see figure 8-11), reject the contact assembly.

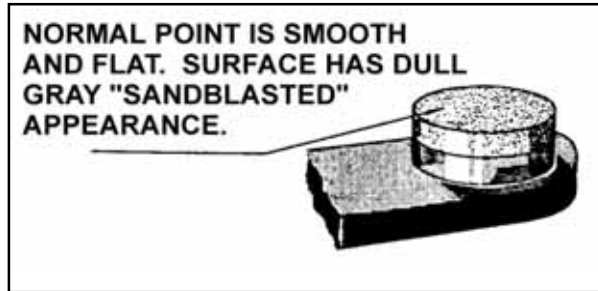

FIGURE 8-9. Normal contact point.

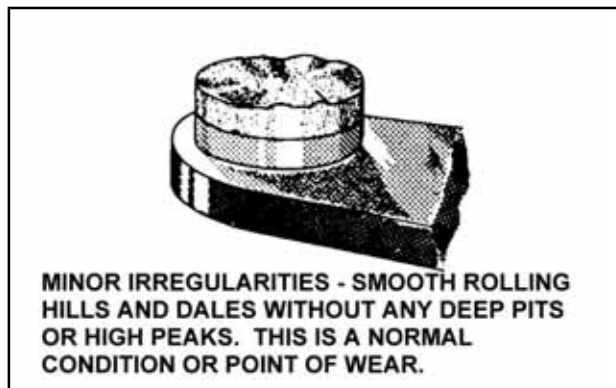

FIGURE 8-10. Point with minor irregularities.

h. Generally, no attempt should be made to dress or stone contact point assemblies; however, if provided, procedures and limits contained in the manufacturer's manuals may be followed.

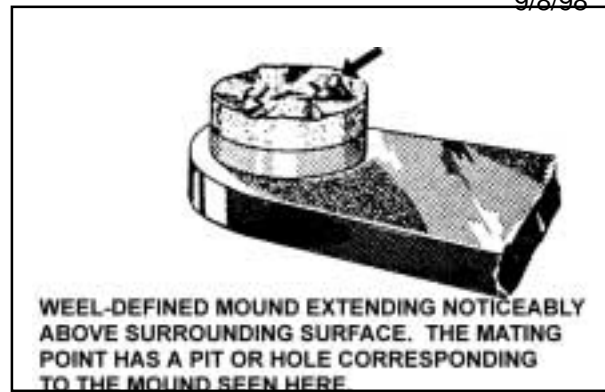

FIGURE 8-11. Point with well-defined mound.

CAUTION: When inspecting the contact points for condition, do not open further than absolutely necessary. Excess tension on the spring will weaken it and adversely affect the performance of the magneto.

i. Adjustment of magneto point gaps must be correct for proper internal timing of a magneto. See applicable manufacturer's publications for internal timing procedures.

j. Check the breaker cam to assure cleanness and smoothness. Check the cam screw for tightness. If new points have been installed, blot a little oil on the cam. In addition, check contact point assembly to ascertain that the cam follower is securely fastened.

k. If the impulse coupling is accessible, inspect for excessive wear on the contact edges of the body and flyweights. In addition, check the flyweights for looseness on the axles.

l. Further examination of the impulse coupling body may disclose cracks caused by exceedingly-tight flyweight axle rivets.

m. Check the magneto ventilators for proper functioning and obstructions. If drilled plugs are used, they should be in the lowest vent hole of the magneto to serve as a drain for condensation and oil.

8-20. MAGNETO-TO-ENGINE TIMING.

While the actual process of timing magnetos to an engine is covered in the engine manufacturer's technical manuals, the following general procedures may be applied.

a. Before installing a new magneto, the correct "E" gap setting specified by the magneto manufacturer should be verified.

b. When setting or checking the magneto-to-engine timing, always turn the crankshaft steadily in the normal direction of rotation to eliminate any error caused by gear backlash.

c. Recheck magneto-to-engine timing after any point-gap adjustment, or after replacement of the breaker points.

d. Never advance the magneto timing beyond the engine timing specification recommended by the engine manufacturer.

e. The possibility of a timing error exists if a timing indicator which attaches to the propeller shaft or spinner of geared engines is used. Engine timing specifications are always given in degrees of crankshaft travel and cannot be applied directly to geared propeller shafts because of the gear ratio. Therefore, the correct position of the propeller shaft, if used for timing, must be determined by multiplying the crankshaft timing angle in degrees before top center (BTC) by the propeller gear ratio.

8-21.—8-29. [RESERVED.]

SECTION 2. FUEL SYSTEMS

8-30. GENERAL. Maintain, service, and adjust aircraft fuel systems and fuel system components in accordance with the applicable manufacturer's maintenance instructions. Certain general fuel system maintenance principles are outlined in the following paragraphs..

8-31. FUEL LINES AND FITTINGS. When fuel system lines are to be replaced or repaired, consider the following fundamentals in addition to the applicable airworthiness requirements. Additional inspection and repair practices for aircraft tubing systems may be found in the Chapter 9, Aircraft Systems and Components.

a. Compatibility of Fittings. All fittings are to be compatible with their mating parts. Although various types of fittings appear to be interchangeable in many cases they have different thread pitch or minor design differences which prevent proper mating and may cause the joint to leak or fail.

b. Routing. Make sure that the line does not chafe against control cables, airframe structure, etc., or come in contact with electrical wiring or conduit. Where physical separation of the fuel lines from electrical wiring or conduit is impracticable, locate the fuel line below the wiring and clamp it securely to the airframe structure. In no case should wiring be supported by the fuel line.

c. Alignment. Locate bends accurately so that the tubing is aligned with all support clamps and end fittings and is not drawn, pulled, or otherwise forced into place by them. Never install a straight length of tubing between two rigidly-mounted fittings. Always incorporate at least one bend between such fittings to absorb strain caused by vibration and temperature changes.

d. Bonding. Bond metallic fuel lines at each point where they are clamped to the structure. Integrally bonded and cushioned line support clamps are preferred to other clamping and bonding methods.

e. Support of Line Units. To prevent possible failure, all fittings heavy enough to cause the line to sag should be supported by means other than the tubing.

f. Support clamps.

(1) Place support clamps or brackets for metallic lines as follows.

Tube O.D.	Approximate distance between supports
1/8"-3/16"-----	9"
1/4"-5/16"-----	12"
3/8"-1/2"-----	16"
5/8"-3/4"-----	22"
1"-1 1/4"-----	30"
1 1/2"-2"-----	40"

(2) Locate clamps or brackets as close to bends as possible to reduce overhang. (See figure 8-12.)

8-32. FUEL TANKS AND CELLS. Welded or riveted fuel tanks that are made of commercially pure aluminum, 3003, 5052, or similar alloys, may be repaired by welding. Tanks made from heat-treatable aluminum alloys are generally assembled by riveting. In case it is necessary to rivet a new piece in a tank, use the same material as used in the tank undergoing repair, and seal the seams with a compound that is insoluble in gasoline. Special sealing compounds are available and should be used in the repair of tanks. Inspect fuel tanks and cells for general condition, security of attachment, and evidence of leakage. Examine fuel tank or cell vent line, fuel line, and sump drain attachment fittings closely.

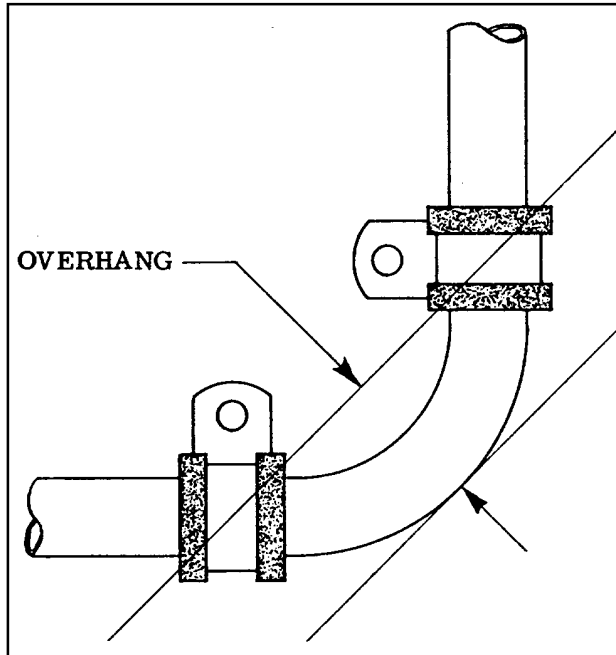

FIGURE 8-12. Location of clamps at tube bends.

CAUTION: Purge de-fueled tanks of explosive fuel/air mixtures in accordance with the manufacturer's service instructions. In the absence of such instructions, utilize an inert gas such as CO₂ as a purgative to assure the total deletion of fuel/air mixtures.

a. Integral Tanks. Examine the interior surfaces and seams for sealant deterioration and corrosion (especially in the sump area). Follow the manufacturer's instructions for repair and cleaning procedures.

b. Internal Metal Tanks. Check the exterior for corrosion and chafing. Dents or other distortion, such as a partially-collapsed tank caused by an obstructed fuel tank vent, can adversely affect fuel quantity gauge accuracy and tank capacity. Check the interior surfaces for corrosion. Pay particular attention to the sump area, especially for those of which sumps are made of cast material. Repairs to the tank may be accomplished in accordance with the practices outlined in the chapter 4, Metal Structure, Welding and Brazing of this AC.

c. Removal of Flux After Welding. It is especially important, after repair by welding, to completely remove all flux in order to avoid possible corrosion. Promptly upon completion of welding, wash the inside and outside of the tank with liberal quantities of hot water and then drain. Next, immerse the tank in either a 5 percent nitric or 5 percent sulfuric acid solution. If the tank cannot be immersed, fill the tank with either solution, and wash the outside with the same solution. Permit the acid to remain in contact with the weld about one hour and then rinse thoroughly with clean water. Test the efficiency of the cleaning operation by applying some acidified 5 percent silver nitrate solution to small quantity of the rinse water used last to wash the tank. If a heavy white precipitate is formed, the cleaning is insufficient and the washing should be repeated.

d. Flexible Fuel Cells. Inspect the interior for checking, cracking, porosity, or other signs of deterioration. Make sure the cell retaining fasteners are properly positioned. If repair or further inspection is required, follow the manufacturer's instructions for cell removal, repair, and installation. Do not allow flexible fuel cells to dry out. Preserve them in accordance with the manufacturer's instructions.

8-33. FUEL TANK CAPS, VENTS, AND OVERFLOW LINES. Inspect the fuel tank caps to determine they are the correct type and size for the installation, and that "O" rings are in good condition.

a. Unvented caps, substituted for vented caps, will cause fuel starvation and possible collapse of the fuel tank or cell. Malfunctioning of this type occurs when the pressure within the tank decreases as the fuel is withdrawn. Eventually, a point is reached where the fuel will no longer flow, and/or the outside atmospheric pressure collapses the tank. Thus,

the effects will occur sooner with a full fuel tank than with one partially filled.

b. Check tank vents and overflow lines thoroughly for condition, obstructions, correct installation, and proper operation of any check valves and ice protection units. Pay particular attention to the location of the tank vents when such information is provided in the manufacturer's service instructions. Inspect for cracked or deteriorated filler opening recess drains, which may allow spilled fuel to accumulate within the wing or fuselage. One method of inspection is to plug the fuel line at the outlet and observe fuel placed in the filler opening recess. If drainage takes place, investigate condition of the line and purge any excess fuel from the wing.

c. Assure that filler opening markings are affixed to, or near, the filler opening; marked according to the applicable airworthiness requirements; and are complete and legible.

8-34. FUEL CROSS-FEED, FIREWALL SHUTOFF, AND TANK SELECTOR VALVES. Inspect these valves for leakage and proper operation as follows.

a. Internal leakage can be checked by placing the appropriate valve in the "off" position, draining the fuel strainer bowl, and observing if fuel continues to flow into it. Check all valves located downstream of boost pumps with the pump(s) operating. Do not operate the pump(s) longer than necessary.

b. External leakage from these units can result in a severe fire hazard, especially if the unit is located under the cabin floor or within a similarly-confined area. Correct the cause of any fuel stains associated with fuel leakage.

c. Selector Handles. Check the operation of each handle or control to see that it indicates the actual position of the selector valve to the placard location. Movement of the selector handle should be smooth and free of binding. Assure that stops and detents have positive action and smooth operational feel. Worn or missing detents and stops can cause unreliable positioning of the fuel selector valve.

d. Worn Linkage. Inaccurate positioning of fuel selector valves can also be caused by worn mechanical linkage between the selector handle and the valve unit. An improper fuel valve position setting can seriously reduce engine power by restricting the available fuel flow. Check universal joints, pins, gears, splines, cams, levers, etc., for wear and excessive clearance which prevent the valve from positioning accurately or from obtaining fully "off" and "on" positions.

e. Assure that required placards are complete and legible. Replace those that are missing or cannot be read easily.

8-35. FUEL PUMPS. Inspect, repair, and overhaul boost pumps, emergency pumps, auxiliary pumps, and engine-driven pumps in accordance with the appropriate manufacturer's instructions.

8-36. FUEL FILTERS, STRAINERS, AND DRAINS. Check each strainer and filter element for contamination. Determine and correct the source of any contaminants found. Replace throw-away filter elements with the recommended type. Examine fuel strainer bowls to see that they are properly installed according to the direction of the fuel flow. Check the operation of all drain devices to see that they operate properly and have positive shutoff action.

8-37. INDICATOR SYSTEMS. Inspect, service, and adjust the fuel indicator systems according to the manufacturer's instructions. Determine that the required placards and instrument markings are complete and legible.

8-38. FUEL SYSTEM PRECAUTIONS. In servicing fuel systems, remember that fuel is flammable and that the danger of fire or explosion always exists. The following precautions should be taken:

a. Aircraft being serviced or having the fuel system repaired must be properly grounded.

b. Spilled fuel must be neutralized or removed as quickly as possible.

c. Open fuel lines must be capped.

d. Fire-extinguishing equipment must always be available.

e. Metal fuel tanks must not be welded or soldered unless they have been adequately purged of fuel fumes. Keeping a tank or cell filled with carbon dioxide will prevent explosion of fuel fumes.

f. Do not use Teflon tape on any fuel lines to avoid getting the tape between the flare and fitting, which can cause fluid leaks.

8-39.—8-44. [RESERVED.]

SECTION 3. EXHAUST SYSTEMS

8-45. GENERAL. Any exhaust system failure should be regarded as a severe hazard. Depending upon the location and type of failure, it can result in carbon monoxide (CO) poisoning of crew and passengers, partial or complete engine power loss, or fire. Exhaust system failures generally reach a maximum rate of occurrence at 100 to 200 hours' operating time, and over 50 percent of the failures occur within 400 hours.

8-46. MUFFLER/HEAT EXCHANGER FAILURES. Approximately one-half of all exhaust system failures are traced to cracks or ruptures in the heat exchanger surfaces used for cabin and carburetor air heat sources.

a. Failures in the heat exchanger's surface (usually the muffler's outer wall) allow exhaust gases to escape directly into the cabin heat system. The failures are, for the most part, attributed to thermal and vibration fatigue cracking in the areas of stress concentration; e.g., tailpipe and stack, inlet-attachment areas. (See figures 8-13 through 8-16.)

b. Failures of the spot welds which attach heat transfer pins, as shown in figure 8-14A, can result in exhaust gas leakage. In addition to the CO hazard, failure of heat exchanger surfaces can permit exhaust gases to be drawn into the engine induction system and cause engine overheating and power loss.

8-47. MANIFOLD/STACK FAILURES. Exhaust manifold and stack failures are also usually fatigue-type failures which occur at welded or clamped joints; e.g., stack-to-flange, stack-to-manifold, muffler connections, or crossover pipe connections. Although these failures are primarily a fire hazard, they also present a CO problem. Exhaust gases can

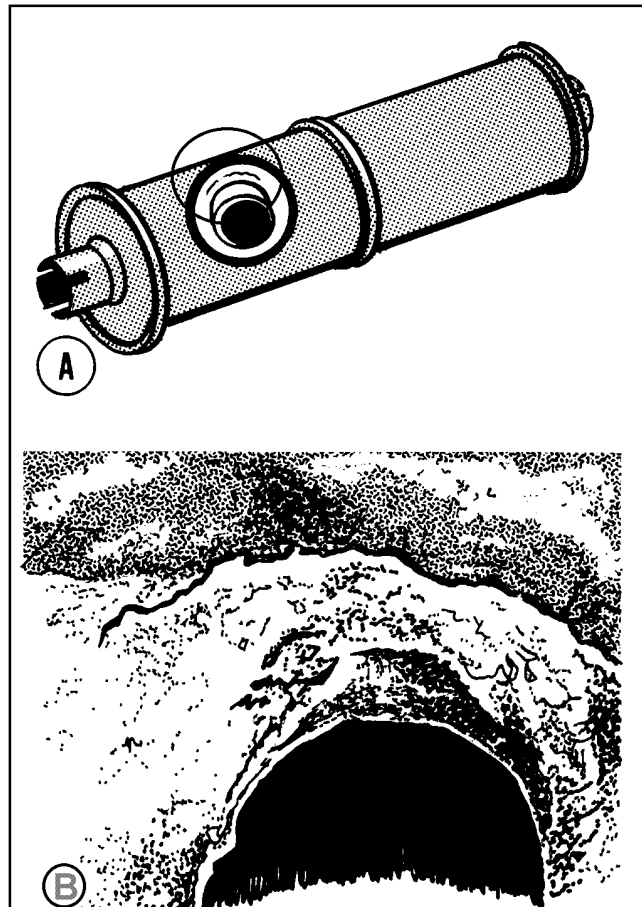

FIGURE 8-13. Typical muffler wall fatigue failure at exhaust outlet. (A. Complete muffler assembly with heat shroud removed; B. Detail view of failure.)

enter the cabin via defective or inadequate seals at firewall openings, wing strut fittings, doors, and wing root openings. Manifold/stack failures, which account for approximately 20 percent of all exhaust system failures, reach a maximum rate of occurrence at about 100 hours' operating time. Over 50 percent of the failures occur within 300 hours.

8-48. INTERNAL MUFFLER FAILURES. Internal failures (baffles, diffusers, etc.) can cause partial or complete engine power loss by restricting the flow of the exhaust gases. (See figures 8-17 through 8-20.)

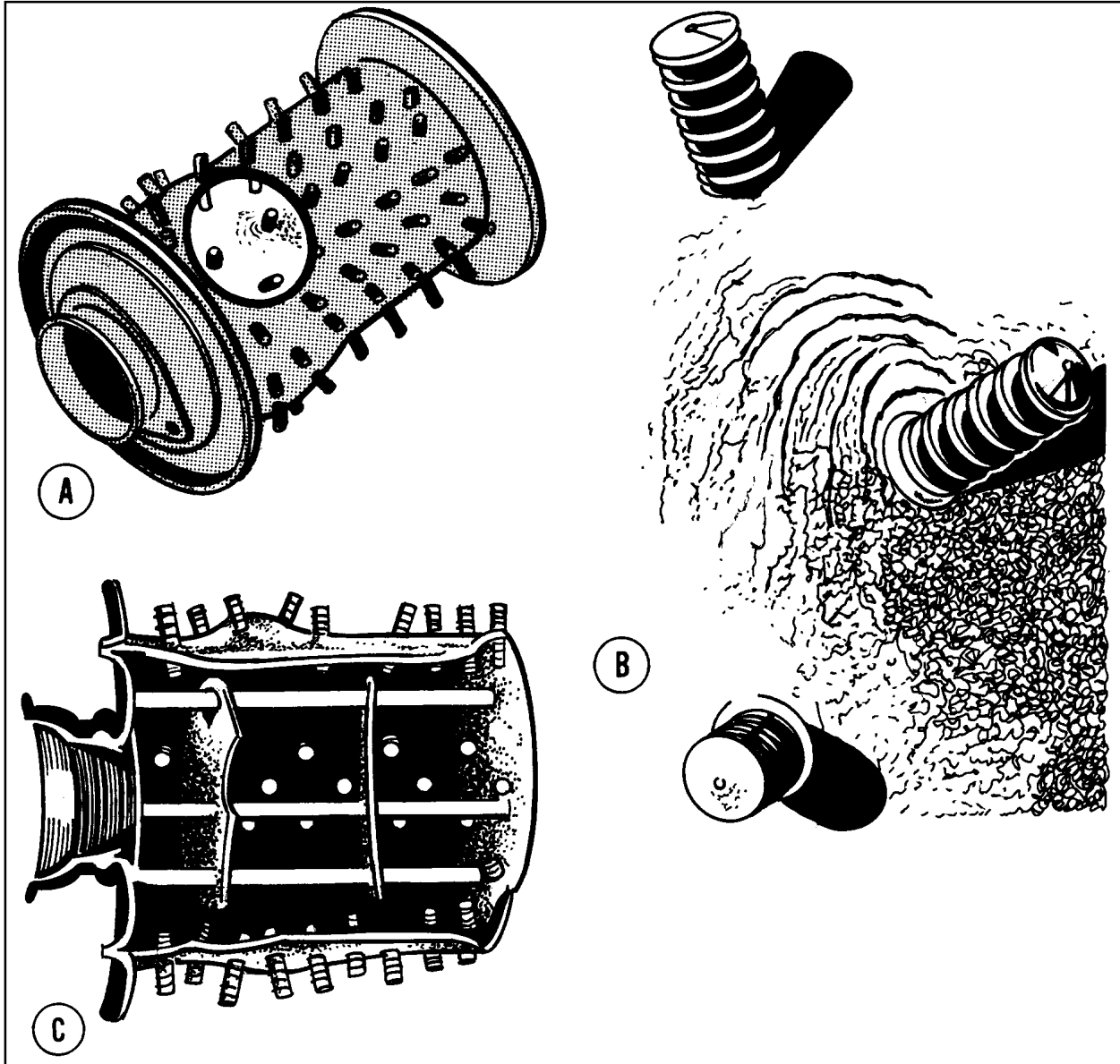

FIGURE 8-14. Typical muffler wall failure. (A. Complete muffler assembly with heat shroud removed; B. Detail view of failure; C. Cross section of failed muffler.)

As opposed to other failures, erosion and carbonizing caused by the extreme thermal conditions are the primary causes of internal failures. Engine after-firing and combustion of unburned fuel within the exhaust system are probable contributing factors.

a. In addition, local hot spot areas caused by uneven exhaust gas flow, result in burning, bulging, and rupture of the outer muffler wall. (See figure 8-14.) As might be

expected, the time required for these failures to develop is longer than that for fatigue failures. Internal muffler failures account for nearly 20 percent of the total number of exhaust system failures.

b. The highest rate of internal muffler failures occurs between 500 and 750 hours of operating time. Engine power loss and excessive back-pressure caused by exhaust outlet blockage may be averted by the installation

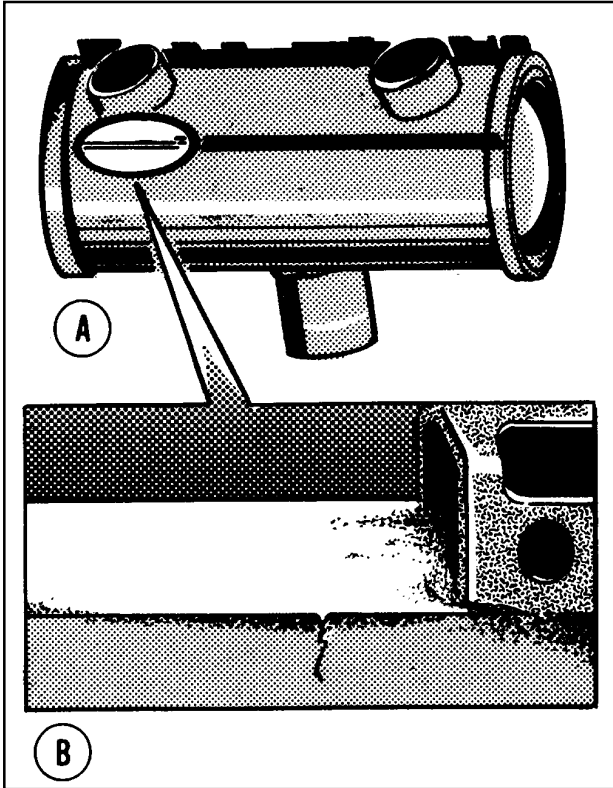

FIGURE 8-15. Typical muffler wall fatigue failure. (A. Complete muffler assembly with heat shroud partially removed; B. Detailed view of failure.)

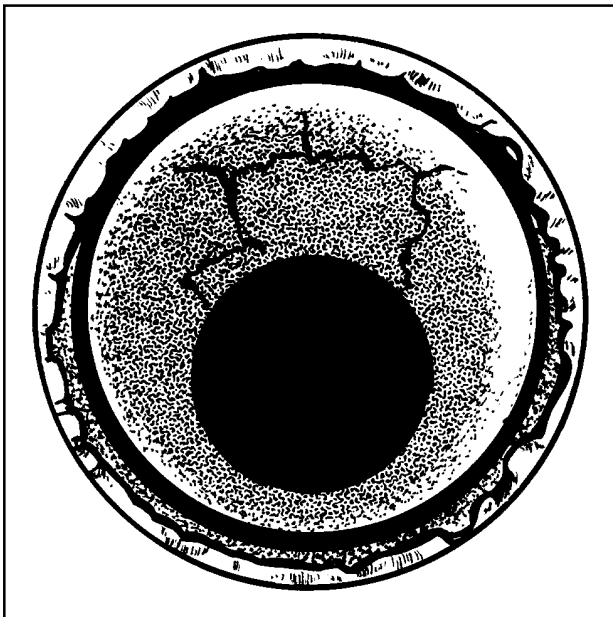

FIGURE 8-16. Typical fatigue failure of muffler end plate at stack inlet.

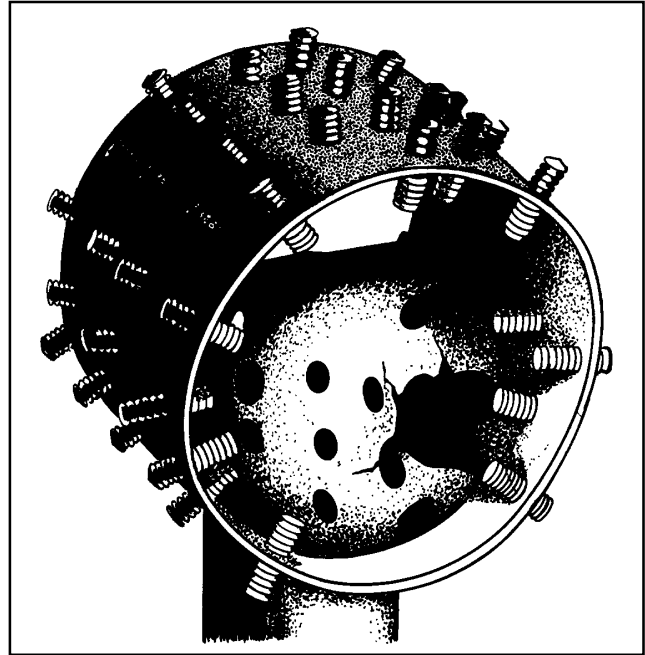

FIGURE 8-17. Section of a muffler showing typical internal baffle failure.

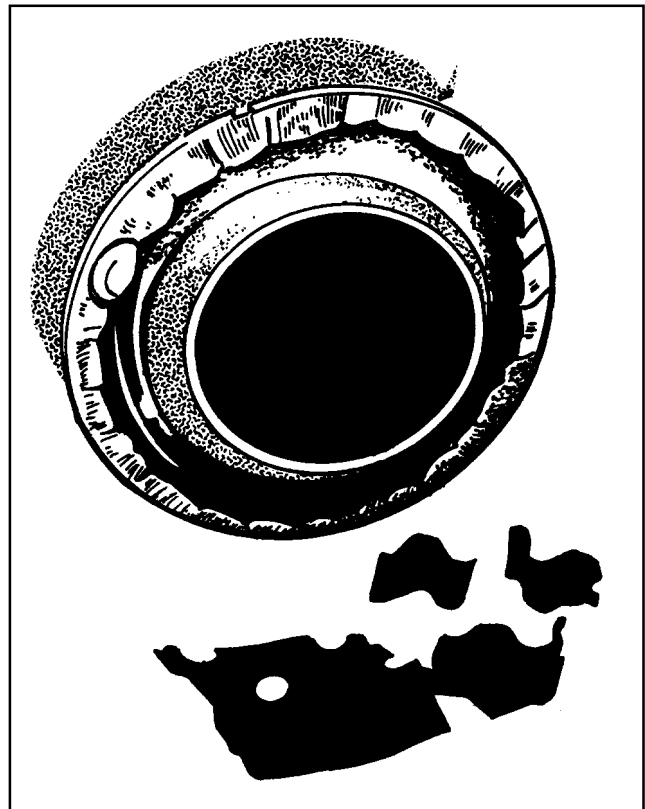

FIGURE 8-18. Loose pieces of a failed internal baffle.

of an exhaust outlet guard as shown in figures 8-21a and 8-21b. The outlet guard may be fabricated from a 3/16-inch stainless steel welding rod.

Form the rod into two "U" shaped segments, approximately 3 inches long and weld onto the exhaust tail pipe as shown in figure 8-21b so that the guard will extend 2 inches inside the exhaust muffler outlet port. Installation of an exhaust outlet guard does not negate the importance of thorough inspection of the internal parts of the muffler or the necessity of replacing defective mufflers.

8-49. INSPECTION. Inspect exhaust systems frequently to ascertain complete system integrity.

CAUTION: Marking of exhaust system parts. Never use lead pencils, carbon based pencils, etc., to mark exhaust system parts. Carbon deposited by those tools will cause cracks from heat concentration and carbonization of the metal. If exhaust system parts must be marked, use chalk, Prussian blue, India ink, or a grease pencil that is carbon-free.

a. Before any cleaning operation, remove the cowling as required to expose the complete exhaust system. Examine cowling and nacelle areas adjacent to exhaust system components for telltale signs of exhaust gas soot indicating possible leakage points. Check to make sure no portion of the exhaust system is being chafed by cowling, engine control cables, or other components. The exhaust system often operates at red-hot temperatures of 1,000 °F or more; therefore, parts such as ignition leads, hoses, fuel lines, and flexible air ducts, should be protected from radiation and convection heating by heat shields or adequate clearance.

b. Remove or loosen all exhaust shields, carburetor and cabin heater mufflers, shrouds, heat blankets, etc., required to permit inspection of the complete system.

c. Perform necessary cleaning operations and inspect all external surfaces of the exhaust system for cracks, dents, and missing parts. Pay particular attention to welds, clamps, supports and support attachment lugs, bracing, slip joints, stack flanges, gaskets, flexible couplings, and etc. (See figures 8-22 and 8-23.) Examine the heel of each bend, areas adjacent to welds, any dented areas, and low spots in the system for thinning and pitting due to internal erosion by combustion products or accumulated moisture. An ice pick (or similar pointed instrument) is useful in probing suspected areas. Disassemble the system as necessary to inspect internal baffles or diffusers.

d. Should a component be inaccessible for a thorough visual inspection or hidden by non-removable parts, remove the component and check for possible leaks by plugging its openings, applying approximately 2 psi internal pressure, and submerging it in water. Any leaks will cause bubbles that can be readily detected. Dry thoroughly before reinstallation.

8-50. REPAIRS. It is generally recommended that exhaust stacks, mufflers, tailpipes, and etc., be replaced with new or reconditioned components rather than repaired. Welded repairs to exhaust systems are complicated by the difficulty of accurately identifying the base metal so that the proper repair materials can be selected. Changes in composition and grain structure of the original base metal further complicates the repair. However, when welded repairs are necessary, follow the general procedures outlined in Chapter 4; Metal Structure, Welding, and Brazing; of this AC. Retain the original contours and make sure that

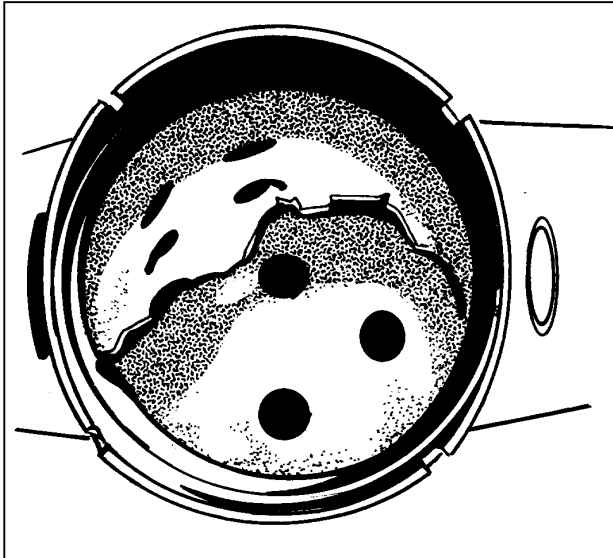

FIGURE 8-19. Failed internal baffle partially obstructing the muffler outlet.

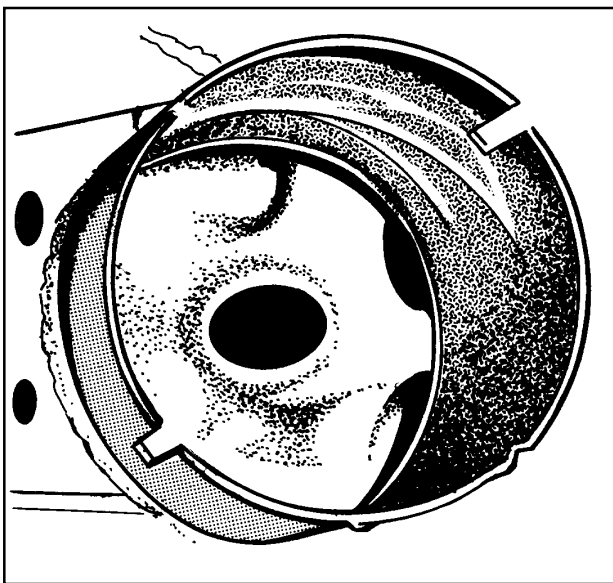

FIGURE 8-20. Failed internal baffle completely obstructing the muffler outlet.

the completed repair has not warped or otherwise affected the alignment of the exhaust system. Repairs or sloppy weld beads, which protrude internally, are not acceptable since they cause local hotspots and may restrict exhaust gas flow. All repairs must meet the manufacturer's specifications. When repairing or replacing exhaust system components, be sure that the proper hardware and clamps are used. Do not substitute steel or low-

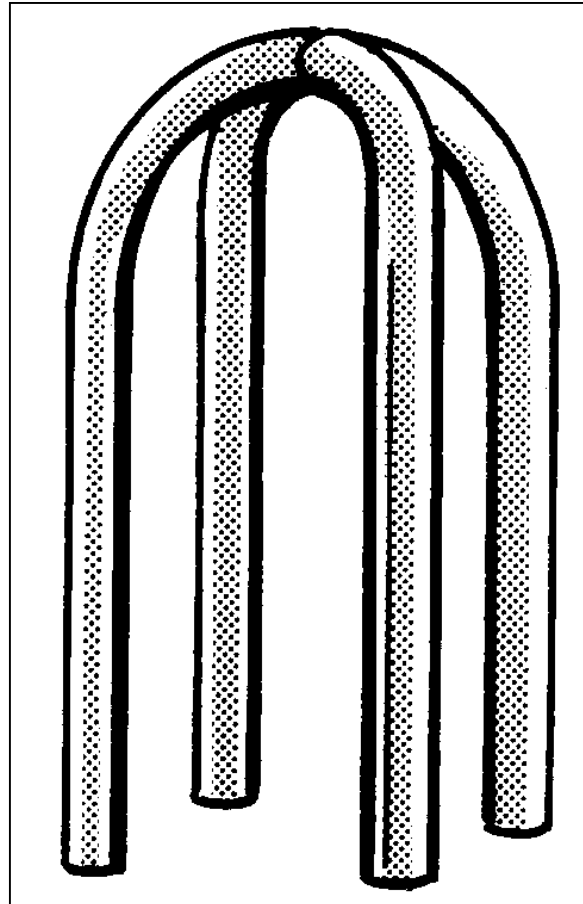

FIGURE 8-21a. Example of exhaust outlet guard.

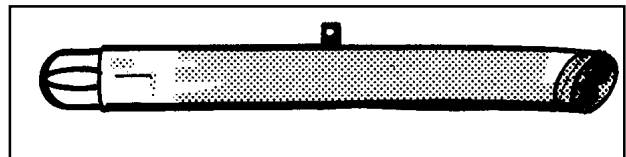

FIGURE 8-21b. Example of exhaust outlet guard installed.

temperature self-locking nuts for brass or special high-temperature locknuts used by the manufacturer. Never reuse old gaskets or old star lock washers. When disassembly is necessary replace gaskets with new ones of the same type provided by the manufacturer.

8-51. TURBO-SUPERCHARGER. When a turbo-supercharger is included, the exhaust system operates under greatly-increased pressure and temperature conditions. Extra precautions should be taken in the exhaust system's care and maintenance. During

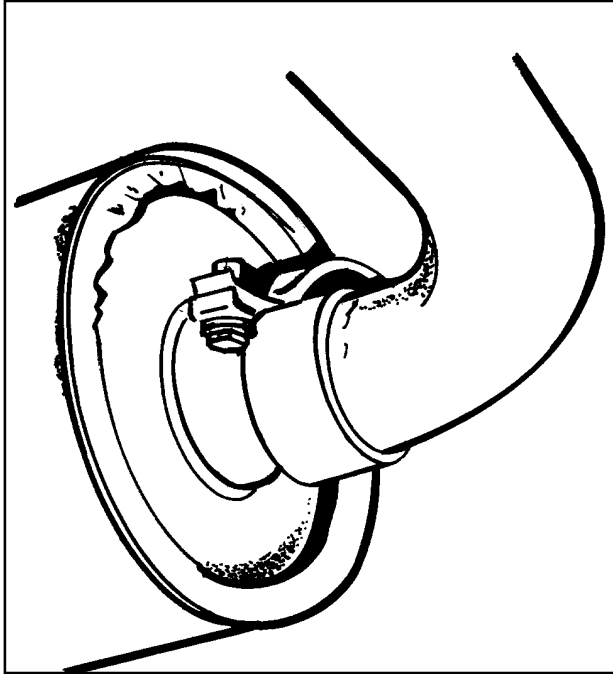

FIGURE 8-22. Effect of improperly positioned exhaust pipe/muffler clamp.

high-altitude operation, the exhaust system pressure is maintained at, or near, sea level values. Due to the pressure differential, any leaks in the system will allow the exhaust gases to escape with a torch-like intensity that can severely damage adjacent structures. A common cause of turbo-supercharger malfunction is coke deposits (carbon buildup) in the waste gate unit causing erratic system operation. Excessive deposit buildups may cause the waste gate valve to stick in the closed position, causing an overboost condition. Coke deposit buildup in the turbo-supercharger itself will cause a gradual loss of power in flight and low deck pressure reading before takeoff. Experience has shown that periodic decoking, or removal of carbon deposits, is necessary to maintain peak efficiency. Clean, repair, overhaul, and adjust turbo-supercharger system components and controls in accordance with the applicable manufacturer's instructions.

8-52. AUGMENTOR SYSTEMS. Inspect augmentor tubes periodically for proper alignment, security of attachment, and general

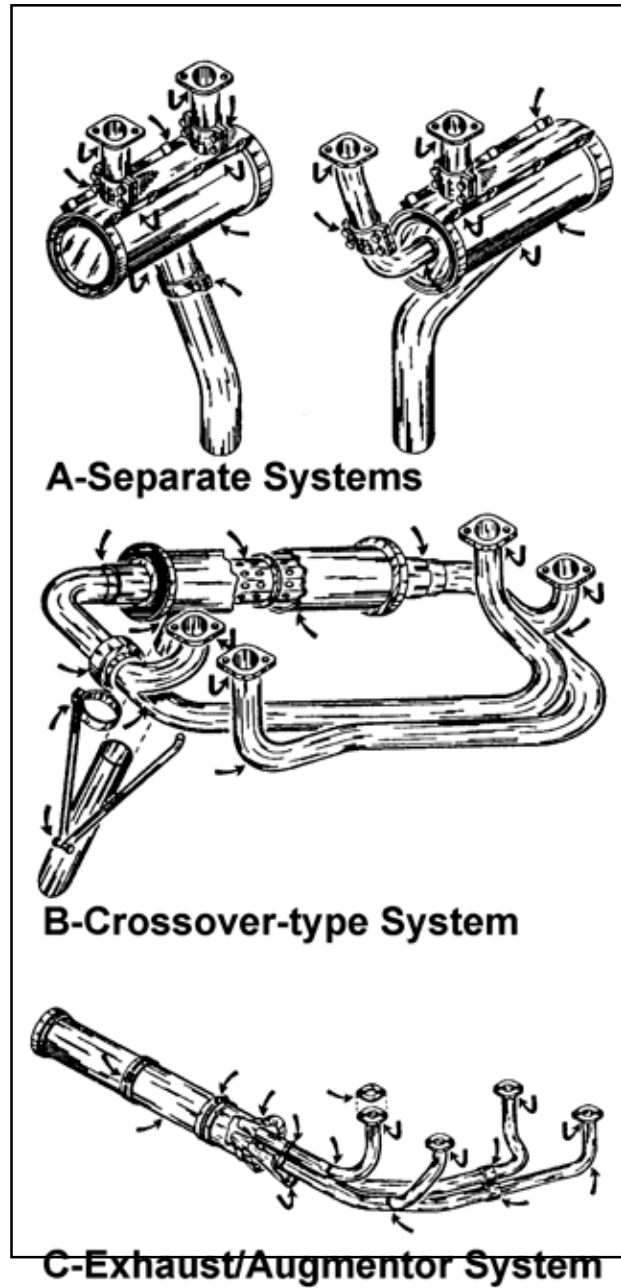

FIGURE 8-23. Primary inspection areas.

overall condition. Regardless of whether or not the augmentor tubes contain heat exchanger surfaces, they should be inspected for cracks along with the remainder of the exhaust system. Cracks can present a fire or CO hazard by allowing exhaust gases to enter nacelle, wing, or cabin areas.

8-53.—8-70. [RESERVED.]

SECTION 4. REPAIR OF METAL PROPELLERS

8-71. GENERAL. Reject damaged blades with model numbers which are on the manufacturer's list of blades that cannot be repaired. Follow the propeller manufacturer's recommendations in all cases, and make repairs in accordance with latest techniques and best industry practices.

NOTE: Title 14 of the Code of Federal Regulations, 14 CFR, part 65 does not allow an airframe and power plant mechanic to perform major repairs to propellers.

8-72. STEEL BLADES. Due to the critical effects of surface injuries and their repair on the fatigue life of steel blades, all repairs must be made in accordance with the manufacturer's instructions.

8-73. ALUMINUM PROPELLER REPAIRS. Aluminum-alloy propellers and blades with dents, cuts, scars, scratches, nicks, leading-edge pitting, etc., may be repaired, provided the removal or treatment does not materially affect the strength, weight, or performance of the blade. Remove these damages or otherwise treat as explained below, unless it is contrary to the manufacturer's instructions or recommendations. More than one injury is not sufficient cause alone for rejection of a blade. A reasonable number of repairs per blade may be made and not necessarily result in a dangerous condition, unless their location with respect to each other is such to form a continuous line of repairs that would materially weaken the blade. Suitable sandpaper or fine-cut files may be used for removing the necessary amount of metal. In each case, the area involved will be smoothly finished with #00 sandpaper or crocus cloth, and each blade from which any appreciable amount of metal has been removed will be properly balanced before it is used. Etch all repairs. To avoid

removal of an excessive amount of metal, local etching should be accomplished at intervals during the process of removing suspected scratches. Upon completion of the repair, carefully inspect the entire blade by etching or anodizing. Remove all effects of the etching process with fine emery paper. Blades identified by the manufacturer as being cold-worked (shot-blasted or cold-rolled) may require peening after repair. Accomplish repair and peening operations on this type of blade in accordance with the manufacturer's instructions. However, it is not permissible in any case topeen down the edges of any injury wherein the operation will lap metal over the injury.

a. Flaws in Edges. Round out nicks, scars, cuts, etc., occurring on the leading edge of aluminum-alloy blades as shown in figure 8-24 (view B). Blades that have the leading edges pitted from normal wear in service may be reworked by removing sufficient material to eliminate the pitting. In this case, remove the metal by starting a sufficient distance from the edge, as shown in figure 8-25, and working forward over the edge in such a way that the contour will remain substantially the same, avoiding abrupt changes in contour. Trailing edges of blades may be treated in substantially the same manner. On the thrust and camber face of blades, remove the metal around any dents, cuts, scars, scratches, nicks, and pits to form shallow saucer-shaped depressions as shown in figure 8-24 (view C). Exercise care to remove the deepest point of the injury and also remove any raised metal around the edges of the injury as shown in figure 8-24 (view A). When repairing blades, figures 8-26 and 8-27 show the maximum reduction in width and thickness that is allowable below the minimum dimensions required by the blade drawing and blade manufacturing specification. Beyond the 90

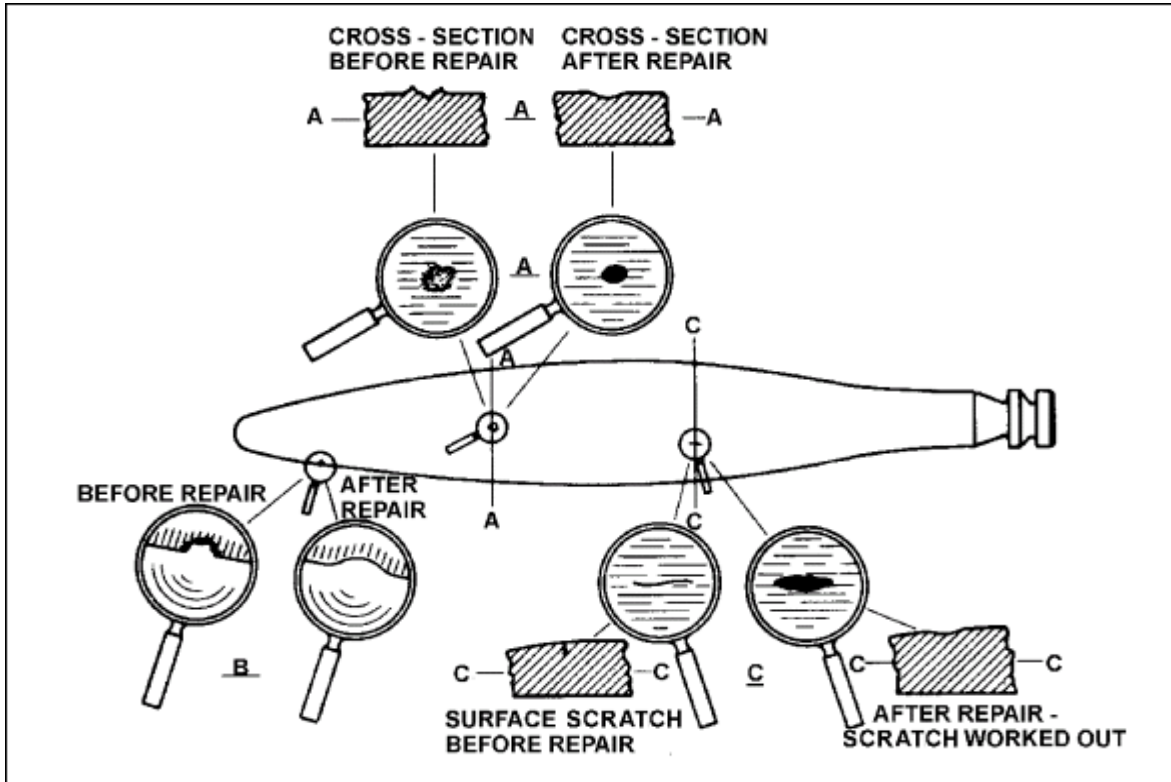

FIGURE 8-24. Method of repairing surface scratches, nicks, etc., on aluminum-alloy propellers.

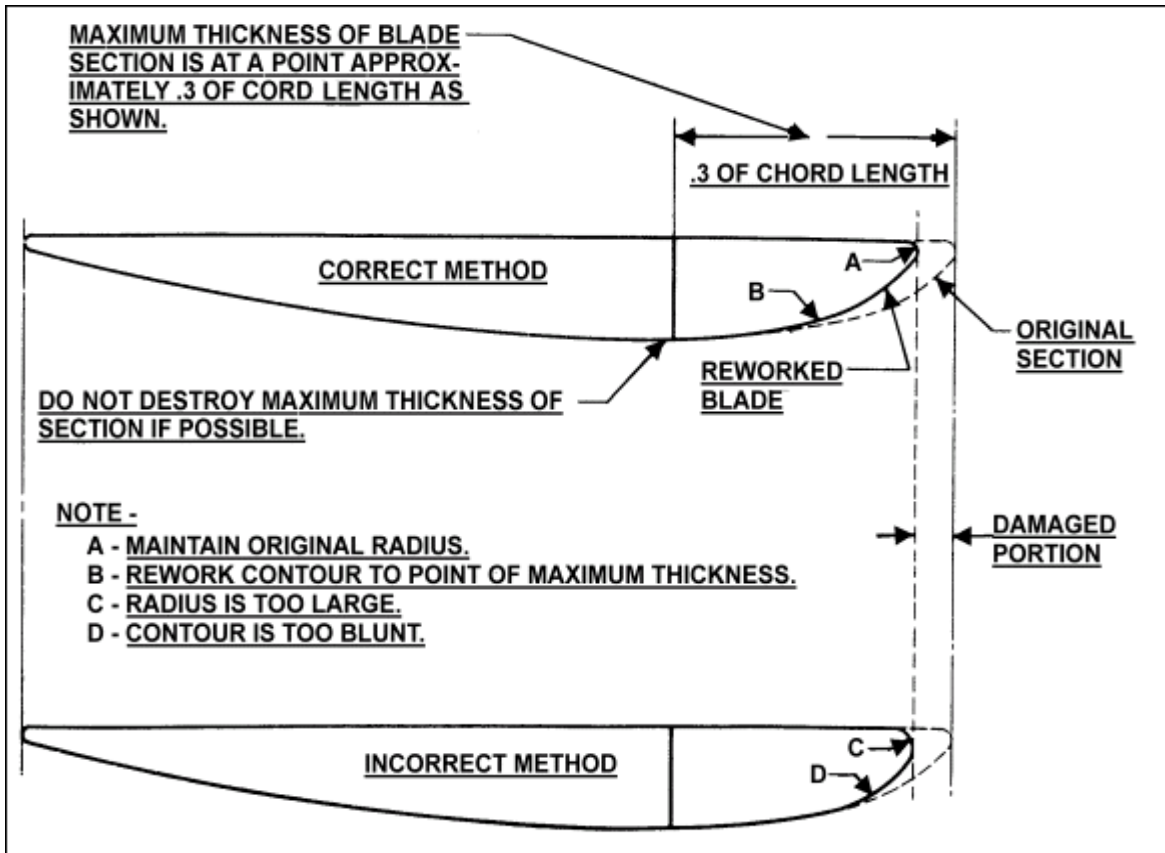

FIGURE 8-25. Correct and incorrect method of reworking leading edge of aluminum-alloy propellers.

90 percent blade radius point, the blade width and thickness may be modified as per the manufacturer's instructions.

b. Shortening Blades. Shortening propeller blades is a major repair. When the removal or treatment of defects on the tip necessitates shortening a blade, shorten each blade used with it and keep such sets of blades together. (See figure 8-26 for acceptable methods.) Mark the shortened blades to correspond with the manufacturer's system of model designation to indicate propeller diameter. In making the repair, it is not permissible to reduce the propeller diameter below the minimum diameter limit shown on the pertinent specification or type certificate data sheet.

c. Straighten Propeller Blades. Never straighten a damaged propeller. Even partial

straightening of blades to permit shipment to a certificated propeller repair facility may result in hidden damage not being detected and an unairworthy propeller being returned to service.

8-74. REPAIR LIMITS. The following limits are those listed in the blade manufacturing specification for aluminum-alloy blades and govern the width and thickness of new blades. These limits are to be used with the pertinent blade drawing to determine the minimum original blade dimensions to which the reduction of figure 8-27 and figure 8-28. may be applied. When repairs reduce the width or thickness of the blade below these limits, reject the blade. The face alignment or track of the propeller should fall within the limits recommended by the manufacturer for new propellers

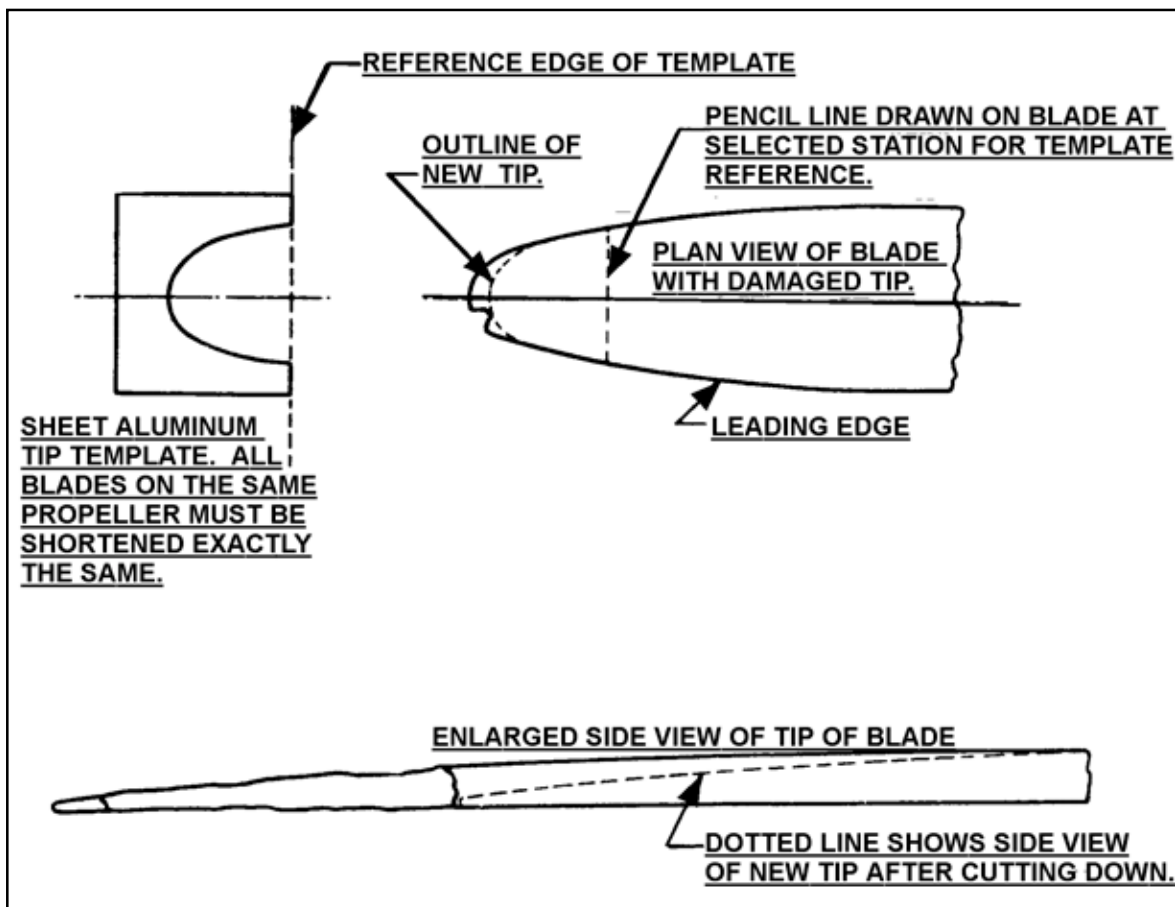

FIGURE 8-26. Method of repairing damaged tip of aluminum-alloy propellers.

a. **No repairs are permitted** to the shanks (roots or hub ends) of aluminum-alloy, adjustable-pitch blades. The shanks must be within manufacturer's limits.

(r_1) is 24 in. from the shank and the original, as manufactured, blade width (w) at the repair location is 1.88 in.

b. **The following two examples** show how to determine the allowable repair limits on aluminum alloy blades.

(a) Step 1. Calculate the blade radius

(r)

$$r = d/2 = (10 \text{ ft } 6 \text{ in})/2 = 126/2 = 63 \text{ in.}$$

(1) Example 1. Determine the blade width repair allowable (Δw) and minimum blade width limit, (w_1) for a blade having a diameter (d) of 10 ft. 6 in. The repair location

(b) Step 2. Calculate percent of blade radius to repair ($r\%$)

$$r\% = r_1/r \times 100 = (24/63) \times 100 = 38$$

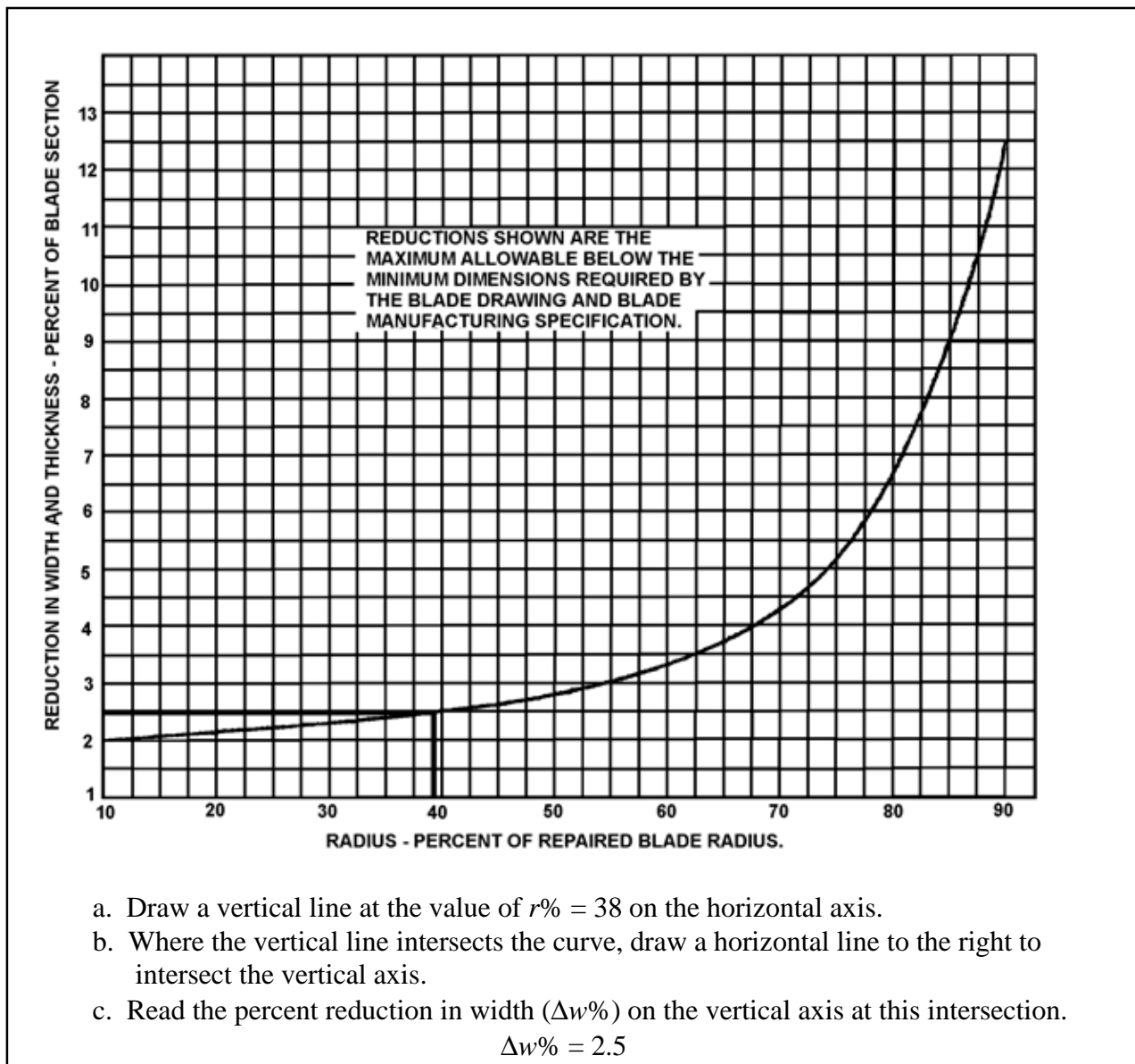

FIGURE 8-27. Example 1. Determine the repair width limits.

(c) Step 3. Determine percent reduction in width ($\Delta w\%$) from figure 8-27.

(d) Step 4. Calculate the blade width repair allowable (Δw)

$$\Delta w = (\Delta w\%) \times (w) \times (0.01) = (2.5) \times (1.88) \times (0.01) = 0.05 \text{ in.}$$

(e) Step 5. Calculate the minimum blade width limit (w_1) at the repair location

$$w_1 = w - \Delta w = 1.88 - 0.05 = 1.83 \text{ in.}$$

(2) Example 2. Determine the blade thickness repair allowable (Δt) and minimum blade thickness limit (t_1) for a blade having a diameter (d) of 10 ft. 6 in. The repair location (r_1) is 43 in. from the shank and the original, as manufactured, blade thickness (t) at the repair location is 0.07 in.

(a) Step 1. Calculate the blade radius (r)

$$r = d/2 = (10 \text{ ft } 6 \text{ in})/2 = 126/2 = 63 \text{ in.}$$

(b) Step 2. Calculate percent of blade radius to repair ($r\%$)

$$r\% = r/r \times 100 = (43/63) \times 100 = 68$$

(c) Step 3. Determine percent reduction in thickness ($\Delta t\%$) from figure 8-28.

(d) Step 4. Calculate the blade thickness repair allowable (Δt)

$$\Delta t = (\Delta t\%) \times (t) \times (0.01) = (4.0) \times (0.07) \times (0.01) = 0.003 \text{ in.}$$

(e) Step 5. Calculate the minimum blade thickness limit (t_1) at the repair location

$$t_1 = t - \Delta t = 0.07 - 0.003 = 0.067 \text{ in.}$$

8-75. STEEL HUBS AND HUB PARTS.

Repairs to steel hubs and parts must be accomplished only in accordance with the manufacturer's recommendations. Welding and remachining is permissible only when covered by manufacturer's service bulletins (SB).

8-76. PROPELLER HUB AND FLANGE REPAIR.

When the fixed-pitch propeller bolt holes in a hub or crankshaft become damaged or oversized, it is permissible to make repairs by using methods (A) or (B) in figure 8-29, or by use of aircraft standard bolts 1/16-inch larger than the original bolts. Make the repairs in accordance with the recommendations of the propeller metal hub manufacturer or the engine manufacturer, as applicable. Obtain from the engine or propeller hub manufacturer suitable flange bushings with threaded or smooth bores, as illustrated in methods (A) or (B) of figure 8-29. Drill the flange and insert the bushings as recommended by the propeller to accommodate the bushings, and protect the holes with 2 coats of aluminum paint or other high moisture-resistant coating. Use bolts of the same size as those originally used. Any of the following combinations may be used: (1) drilled head bolt and castellated nut, (2) drilled head bolt and threaded bushing, or (3) undrilled bolt and self-locking nut. Where it is desirable to use oversized bolts, obtain suitable aircraft-standard bolts 1/16-inch larger than the original bolts. Enlarge the crankshaft propeller flange holes and the propeller hub holes sufficiently to accommodate the new bolts without more than 0.005-inch clearance. Such reboring will be permitted only once. Further repairs of bolt holes may be in accordance with the methods listed in (A) or (B) of figure 8-29.

NOTE: Method (A) or (B) is preferred over the oversized bolt method, because a propeller hub flange re-drilled in accordance with this latter

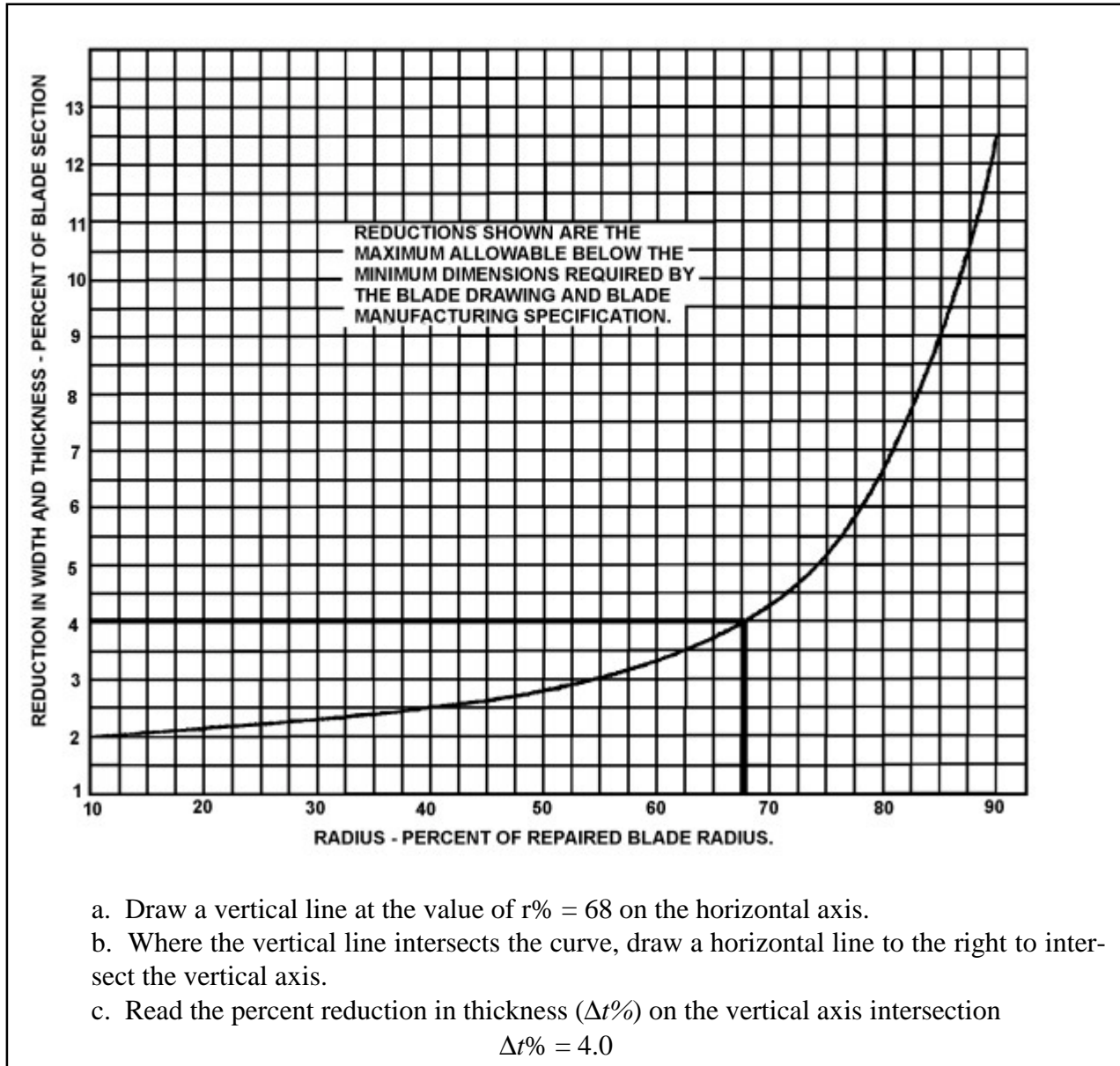

FIGURE 8-28. Example 2. Determine the repair thickness limits.

method will always require the re-drilling of all new propellers subsequently used with the re-drilled flange.

8-77. CONTROL SYSTEMS. Components used to control the operation of certificated propellers should be inspected, repaired, assembled, and/or tested in accordance with the manufacturer's recommendations. Only those repairs which are covered by the manufacturer's recommendations should be made, and

only those replacement parts which are approved under 14 CFR, part 21 should be used.

8-78. DEICING SYSTEMS. Components used in propeller deicing systems should be inspected, repaired, assembled, and/or tested in accordance with the manufacturer's recommendations. Only those repairs which are covered by the manufacturer's recommendations should be made, and only those replacement parts which are approved under 14 CFR, part 21 should be used.

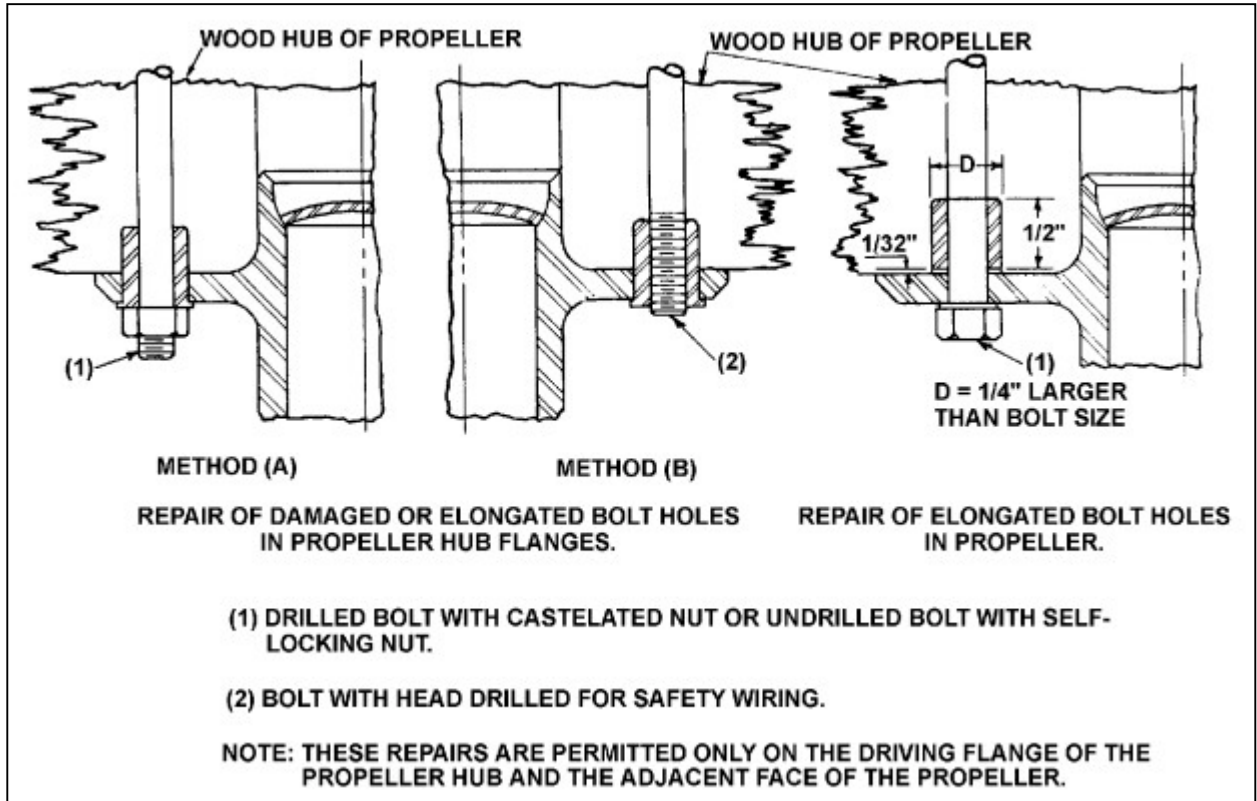

FIGURE 8-29. Repair of fixed-pitch hub and propeller with elongated or damaged bolt holes.

8-79.—8-90. [RESERVED.]

SECTION 5. INSPECTION OF PROPELLERS

8-91. GENERAL. All propellers, regardless of the material from which they are made, should be regularly and carefully inspected for any possible defect. Any doubtful condition, such as looseness of parts, nicks, cracks, scratches, bruises, or loss of finish should be carefully investigated and the condition checked against repair and maintenance specifications for that particular type of propeller. Any propeller that has struck a foreign object during service should be promptly inspected for possible damage in accordance with the propeller manufacturer's prescribed procedures and, if necessary, repaired according to the manufacturer's instructions. If the propeller is damaged beyond the repair limits established by the propeller manufacturer, and a replacement is necessary, install the same make/model approved or alternate as specified in the equipment list, applicable FAA Aircraft Specification, Type Certificate Data Sheet (TCDS), or Supplemental Type Certificate (STC). A sample manufacturer's propeller inspection checklist is shown in table 8-2. It shows the items to be inspected and the inspection intervals.

8-92. WOOD OR COMPOSITION PROPELLERS AND BLADES. Wood propellers are usually found on low-power, reciprocating engines while composition (Carbon fiber, Kevlar) propellers are used on high horsepower reciprocating and turbine engines. Due to the nature of wood, these propellers should be inspected frequently to assure airworthiness. Inspect for defects such as cracks, dents, warpage, glue failure, delamination defects in the finish, and charring of the wood between the propeller and the flange due to loose propeller mounting bolts. Composition propellers should be inspected in accordance with the propeller manufacturer's instructions.

a. Fixed-pitch propellers are normally removed from the engine at engine overhaul periods. Whenever the propeller is removed, visually inspect the rear surface for any indication of cracks. When any defects are found, disassemble the metal hub from the propeller. Inspect the hub bolts for wear and cracks at the head and threads, and if cracked or worn, replace with new equivalent bolts. Inspect for elongated bolt holes, enlarged hub bore, and for cracks inside the bore or anywhere on the propeller. Repair propellers found with any of these defects. If no defects are found, the propeller may be reinstalled on the engine. Before installation, touch up with varnish all places where the finish is worn thin, scratched, or nicked. Track and balance the propeller, and coat the hub bore and bolt holes with some moisture preventive such as asphalt varnish. In case the hub flange is integral with the crankshaft of the engine, final track the propeller after it is installed on the engine. In all cases where a separate metal hub is used, make a final balance and track with the hub installed on the propeller.

b. On new, fixed-pitch propeller installations, inspect the bolts for proper torque after the first flight and after the first 25 hours of flying. Thereafter, inspect and check the bolts for proper torque at least every 50 hours. No definite time interval can be specified, since a bolt's proper torque is affected by changes in the wood caused by the moisture content of the air where the airplane is flown and stored. During wet weather, some moisture is apt to enter the propeller wood through the holes drilled in the hub. The wood then swells, and because expansion is limited by the bolts extending between the two flanges, some of the wood fibers become crushed. Later, when the propeller dries out during dry weather or due

TABLE 8-2. Sample manufacturer’s propeller inspection checklist.

Nature of Inspection	Engine Operating Hours			
	50	100	500	1000
PROPELLER GROUP				
1. Inspect spinner and back plate for cracks.....	0	0	0	0
2. Inspect blades for nicks and cracks.....	0	0	0	0
3. Check for grease and oil leaks.....	0	0	0	0
4. Lubricate propeller per Lubrication Chart.....	0	0	0	0
5. Check spinner mounting Brackets for cracks.....		0	0	0
6. Check propeller mounting bolts and safety (Check torque if safety is broken).....		0	0	0
7. Inspect hub parts for cracks and corrosion.....		0	0	0
8. Rotate blades of constant speed propeller and check for tightness in hub pilot tube.....		0	0	0
9. Remove constant speed propeller; remove sludge from propeller and crankshaft.....			0	0
10. Inspect complete propeller and spinner assembly for security, chafing, cracks, deterioration, wear and correct installation.....		0	0	0
11. Check propeller air pressure (at least once a month).....	0	0	0	0
12. Overhaul propeller.....				0

to heat from the engine, a certain amount of propeller hub shrinkage takes place, and the wood no longer completely fills the space between the two hub flanges. Consequently, the hub bolts become loose.

c. In-flight tip failures may be avoided by frequent inspections of the metal cap, leading edge strip, and surrounding areas. Inspect for such defects as looseness or slipping, separation of soldered joints, loose screws, loose rivets, breaks, cracks, eroded sections, and corrosion. Inspect for separation between the metal leading edge and the cap, which would indicate the cap is moving outward in the direction of centrifugal force. This condition is often accompanied by discoloration and loose rivets. Inspect the tip for cracks by grasping it with the hand and slightly twisting about the longitudinal blade centerline and by slightly bending the tip backward and forward. If the leading edge and the cap have separated, carefully inspect for cracks at this point. Cracks usually start at the leading edge of the blade. A fine line appearing in the fabric or plastic may indicate a crack in the wood. Check the trailing edge of the propeller blades for bonding, separation, or damage.

d. Examine the wood close to the metal sleeve of wood blades for cracks extending outward on the blade. These cracks sometimes

occur at the threaded ends of the lag screws and may be an indication of internal cracking of the wood. Check the tightness of the lag screws, which attach the metal sleeve to the wood blade, in accordance with the manufacturer’s instructions. Inspect and protect the shank areas of composition blades next to the metal sleeve in the same manner as that used for wood blades.

8-93. METAL PROPELLERS AND BLADES. These propellers and blades are generally susceptible to fatigue failure resulting from the concentration of stresses at the bottoms of sharp nicks, cuts, and scratches. It is necessary, therefore, to frequently and carefully inspect them for such injuries. Propeller manufacturers publish SB’s and instructions which prescribe the manner in which these inspections are to be accomplished. Additional information is also available in AC 20-37D, Aircraft Metal Propeller Maintenance.

a. Steel Blade Inspection. The inspection of steel blades may be accomplished by either visual, fluorescent penetrant (see chapter 5), or magnetic particle inspection. The visual inspection is easier if the steel blades are covered with engine oil or rust-preventive compound. The full length of the leading edge, especially near the tip, the full length of the trailing edge, the grooves and shoulders on the shank, and all

dents and scars should be examined with a magnifying glass to decide whether defects are scratches or cracks.

b. Aluminum Propellers and Blades.

Carefully inspect aluminum propellers and blades for cracks and other flaws. A transverse crack or flaw of any size is cause for rejection. Multiple deep nicks and gouges on the leading edge and face of the blade is cause for rejection. Use dye penetrant or fluorescent dye penetrant to confirm suspected cracks found in the propeller. Refer any unusual condition or appearance revealed by these inspections to the manufacturer.

c. Limitations.

(1) Corrosion may be present on propeller blades in varying amounts. Before performing any inspection process, maintenance personnel must examine the specific type and extent of the corrosion. (See chapter 6, and/or refer to AC 43-4A, Corrosion Control For Aircraft.)

(2) Corrosion, other than small areas (6 square inches or less) of light surface type corrosion, may require propeller removal and reconditioning by a qualified propeller repair facility. When intergranular corrosion is present, the repair can be properly accomplished only by an appropriately certificated propeller repair facility. Corrosion pitting under propeller blade decals should be removed as described in the propeller manufacturer's SB's and applicable airworthiness directives (AD).

(3) Unauthorized straightening of blade, following a ground strike or other damage, can create conditions that lead to immediate blade failure. These unapproved major repairs may sometimes be detected by careful inspection of the leading edges and the flat face portion of the blade. Any deviation of the flat portion, such as bows or kinks, may indicate

unauthorized straightening of the blade. Sighting along the leading edge of a propeller blade for any signs of bending can provide evidence of unapproved blade straightening. Blades should be examined for any discoloration that would indicate unauthorized heating. Blades that have been heated for any repair must be rejected, since only cold straightening is authorized. All blades showing evidence of unapproved repairs should be rejected. When bent propellers are shipped to an approved repair facility for inspection and repair, the propeller should never be straightened by field service personnel to facilitate shipping, because this procedure can conceal damage. Propeller tip damage will sometimes lead maintenance personnel to consider removing damaged material from the blade tips. However, propellers are often manufactured with a particular diameter to minimize vibration. Unless the TCDS and both the engine and propeller manufacturers specifically permit shortening of the blades on a particular propeller, any shortening of the blades would probably create an unairworthy condition. When conditions warrant, inspect the blade tips for evidence of shortening and, if necessary, measure the propeller diameter to determine if it has been changed by an unauthorized repair.

8-94. PROPELLER HUB.

a. Fixed Pitch.

(1) Inspection procedures require removal of the propeller spinner for examination of the prop hub area. Cracks may be present in the hub area between or adjacent to bolt holes and along the hub pilot bore. Cracks in these areas cannot be repaired and require immediate scrapping of the propeller.

(2) Propeller attach bolts should be examined for looseness or an unsafetied or cracked condition. Cracked or broken bolts are usually the result of overtightening. Correct

torquing procedures require all bolt threads to be dry, clean, and free of any lubrication before torquing.

b. Controllable Pitch.

(1) Inspect controllable pitch propellers frequently to determine that all parts are lubricated properly. It is especially recommended that all lubrication be accomplished in accordance with the propeller manufacturer's instructions.

(2) Complete inspection/servicing requires the removal of the spinner for examination and servicing of the propeller hub and blade clamp area. All inspections and servicing of the pitch control mechanism should follow the recommendations of the propeller, engine, and airframe manufacturers. Propellers must be in compliance with applicable AD's and manufacturer's SB's.

(3) The hub, blade clamps, and pitch change mechanisms should be inspected for corrosion from all sources, including rain, snow, and bird droppings that may have entered through the spinner openings. Examine the hub area for oil and grease leaks, missing grease-fitting caps, and leaking or missing grease fittings.

(4) Propeller domes should be checked for leaks, both at the seals and on the fill valve (if so equipped). The dome valve may be leak-tested by applying soapy water over the fill valve end. Domes should be serviced only with nitrogen or dry air in accordance with the manufacturer's recommendations. When propeller domes are inspected and found filled with oil, the propeller should be removed and inspected/repared by an appropriately-rated repair facility.

(5) It is especially recommended that all lubrication be accomplished at the periods and

in the manner specified by the propeller manufacturer. On makes and models with a grease fitting on the hub, before greasing the hub remove the grease fitting opposite the one to which you are going to add grease. This will allow the excess grease and pressure to exit through the grease fitting hole rather than the hub seal.

(6) Fiber-block, pitch-change mechanisms should be inspected for deterioration, fit, and the security of the pitch-clamp forks.

(7) Certain models of full-feathering propellers use spring-loaded pins to retain the feathered blade position. Spring and pin units should be cleaned, inspected, and relubricated per the manufacturer's recommendations and applicable AD's.

(8) Pitch change counterweights on blade clamps should be inspected for security, safety, and to ensure that adequate counterweight clearance exists within the spinner.

8-95. TACHOMETER INSPECTION.

Due to the exceptionally high stresses that may be generated by particular propeller/engine combinations at certain engine revolutions per minute (RPM), many propeller and aircraft manufacturers have established areas of RPM restrictions and other restrictions on maximum RPM for some models. Some RPM limits do not exceed 3 percent of the maximum RPM permitted, and a slow-running tachometer can cause an engine to run past the maximum RPM limits. Since there are no post-manufacture accuracy requirements for engine tachometers, tachometer inaccuracy could lead to propeller failure, excessive vibration, or unscheduled maintenance. If the tachometer exceeds 2 percent (plus or minus) of the tested RPM, replace it.

8-96.—8-106. [RESERVED.]

SECTION 6. PROPELLER TRACKING AND VIBRATION

8-107. GENERAL. To ensure smooth powerplant operations, first start with a properly-installed propeller. Each propeller should be checked for proper tracking (blades rotating in the same plane of rotation). Manufacturer's recommendations should in all cases be followed.

8-108. PROPELLER TRACKING

CHECK. The following is a simple procedure that can be accomplished in less than 30 minutes:

a. Chock the aircraft so it cannot be moved.

b. Remove one spark plug from each cylinder. This will make the propeller easier and safer to turn.

c. Rotate one of the blades so it is pointing down.

d. Place a solid object (e.g. a heavy wooden block that is at least a couple of inches higher off the ground than the distance between the propeller tip and the ground) next to the propeller tip so that it just touches (see figure 8-30), or attach a pointer/indicator to the cowling itself.

e. Rotate the propeller slowly to see if the next blade "tracks" through the same point (touches the block/pointer). Each blade track should be within 1/16-inch (plus or minus) from the opposite blade's track.

f. If the propeller is out of track, it may be due to one or more propeller blades being bent, a bent propeller flange, or propeller mounting bolts that are either over or under-torqued. An out-of-track propeller will cause vibration and stress to the airframe and engine, and may cause premature propeller failure.

8-109. VIBRATION. Although vibration can be caused by the propeller, there are numerous other possible sources of vibration which can make troubleshooting difficult.

a. If a propeller vibrates, whether due to balance, angle, or track problems, it typically vibrates, throughout the entire RPM range, although the intensity of the vibration may vary with the RPM. If a vibration occurs only at one particular RPM or within a limited RPM range (e.g. 2200-2350 RPM), the vibration is not normally a propeller problem but a problem with a poor engine/propeller match.

b. If a propeller vibration is suspected but cannot be positively determined, if possible, the ideal troubleshooting method is to temporarily replace the propeller with one which is known to be airworthy and test fly the aircraft.

c. There are numerous allowable tolerances in blade angles, balance, track, and blade width and thickness dimensions. These tolerances have been established through many years of experience. The degree to which these factors affect vibration is sometimes disputed and can involve significant repair bills, which may or may not cure a vibration problem. Reliance upon experienced, reputable propeller repair stations is the owner's best method of dealing with these problems.

d. Blade shake is not the source of vibration problems. Once the engine is running, centrifugal force holds the blades firmly (approximately 30-40,000 lbs.) against blade bearings.

e. Cabin vibration can sometimes be improved by reindexing the propeller to the crankshaft. The propeller can be removed, rotated 180°, and re-installed.

f. **The propeller spinner** can be a contributing factor to an out-of-balance condition. An indication of this would be a noticeable spinner “wobble” while the engine is running.

This condition is normally caused by inadequate shimming of the spinner front support or a cracked or deformed spinner.

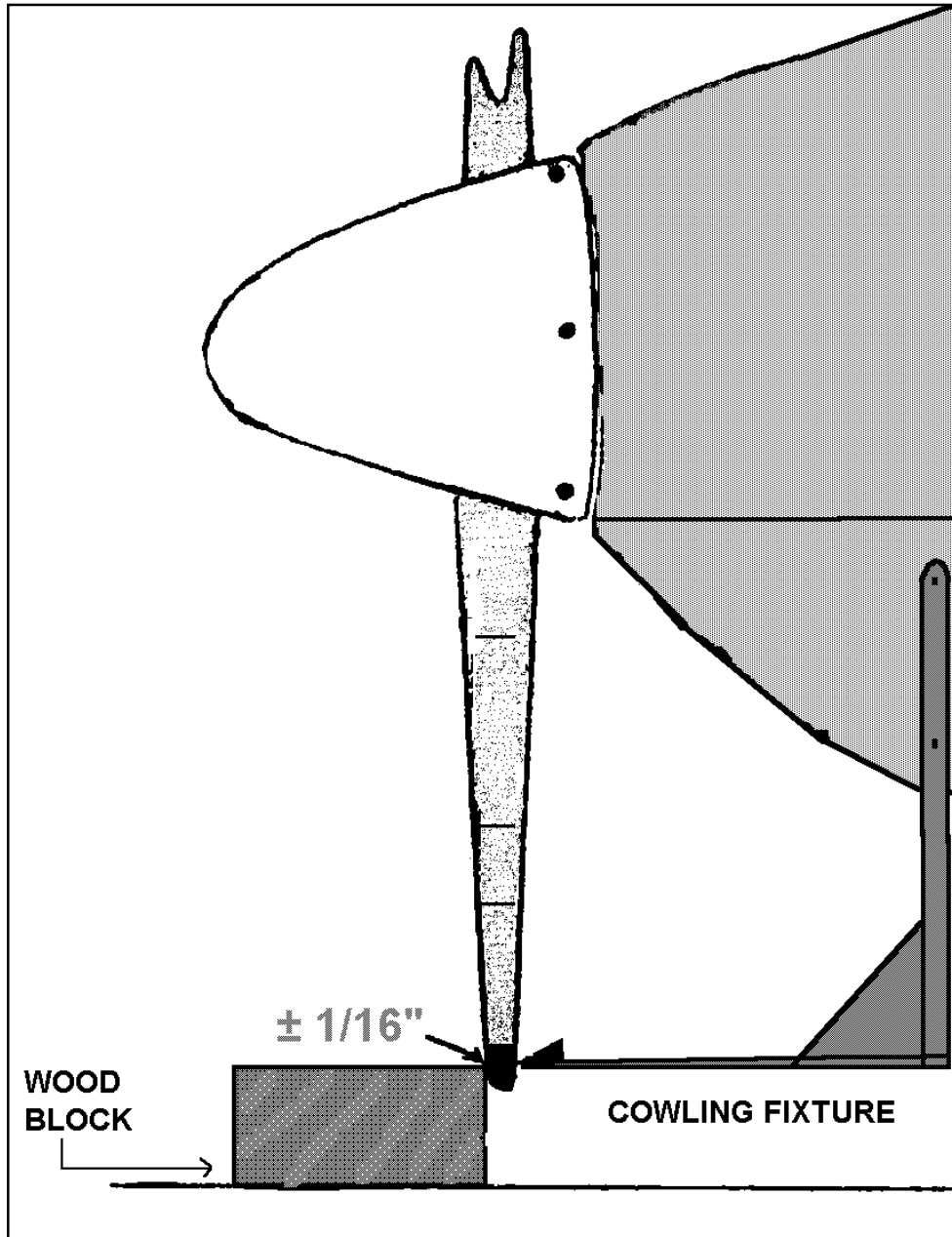

FIGURE 8-30. Propeller tracking (wood block or cowling fixture shown).

8-110.—8-129. [RESERVED.]